

PROGRAMMA / PROGRAM

03/A

**CLASSIC CARS
& EXOTICS**

IMPIANTI DI SCARICO
EXHAUST SYSTEMS



ALFA ROMEO

BUGATTI

DE TOMASO

FERRARI

FIAT

LAMBORGHINI

LANCIA

MASERATI

MATRA-SIMCA

PORSCHE

Made in Italy



INDICE - INDEX

ALFA ROMEO

Giulia	3
Giulietta	3
GT - GTV	3
Montreal	4
Spider	4
75	4

BUGATTI

EB 110	5
--------	---

DE TOMASO

Deauville	5
Longchamp	5
Mangusta	5
Pantera	6

FERRARI

BB 365 / 512	27
Dino 206 - 246	7
Dino 208	8
F40	14
Mondial	9>11
Mondial T	12
Testarossa	28
208 - 208 Turbo	8
212	15
250	15>19
275	20
288 gto	13
308	9-10
328	11
330	21
348	12
355	12
360	13
365 gt 2+2 (Altair)	21
365 gtb/4 (Daytona)	22
365 gtc-gts	21
365 gtc/4 - gt/4 2+2	23
400 gt - gti	24
400 Super America	23
410 SA - Superfast	24
412	24

430	13
456	25
500 Super Fast	25
512 tr-m	28
550	25
575	26
599	26
612	26

FIAT

X!/9	29
124 Abarth-Rally	29
124 Spider	29
131 Abarth-Rally	29
500	29

LAMBORGHINI

Aventador	30
Countach	31-32
Diablo	33
Espada	34
Gallardo	36
Islero	34
Jalpa	35
Jarama	35
LM 002	36
Miura	37
Murcielago	36
Silhouette	38
Urraco	38
350 gt	30
400 gt	30

LANCIA

Delta HF	39
Montecarlo	39
Stratos	39

MASERATI

Biturbo	40
Bora	41
GT 3.2 (turbo)	46
GT 4.2 (aspirato)	46
Ghibli	41

Granturismo	46
Karif	40
Khamsin	42
Kyalami	42
Indy	42
Merak	43
Mexico	43
Mistral	44
Quattroporte	44-45
Sebring	45
Shamal	46
3500 gt	40

MATRA-SIMCA

Bagheera	47
----------	----

PORSCHE

928	47
928 S	47

UNIVERSALI

Sport Silencers	47
-----------------	----

ACCESSORI

Accessori - Mounting	48-49
----------------------	-------

ALFA ROMEO: giulietta - giulia - gt - gtv

1 Solo per modelli con flange a 6 fori
Only models with 6 holes flanges

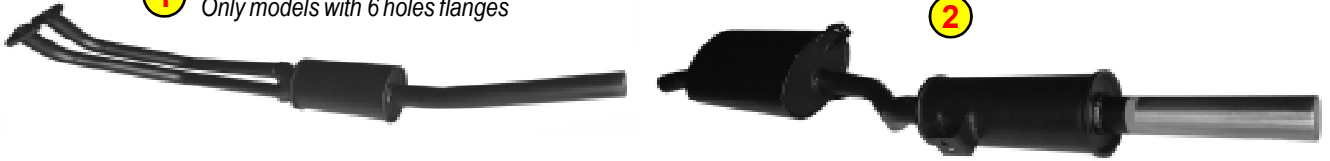

Giulietta Spider 1.3 58>65

Giulietta (Giulia) Spider 1.6 - 1.6 Veloce 55>65

Giulietta Sprint 1.6 Speciale SS + Zagato SZ 60>66

1) Silenziatore Anteriore / Front Silencer

(101023000200)

ref. AR 5003

2) Silenziatore / Silencer

(101023000200)

ref. AR 4917

1 Solo per modelli con flange a 6 fori
Only models with 6 holes flanges

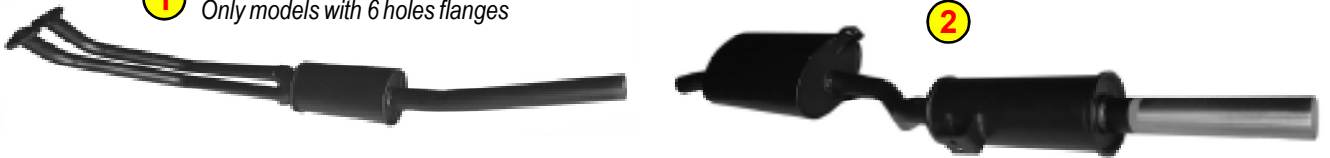

Giulietta Sprint 1.3 58>65

Giulietta (Giulia) Spint 1.6 - 1.6 Veloce 54>65

1) Silenziatore Anteriore / Front Silencer

(---

ref. AR 5003

2) Silenziatore / Silencer

(---

ref. AR 4907



Giulia Berlina 1.3 - 1.6 63>78

GT 1.3 - 1.6 64>76

GT 1750 - 2.0 71>76

1) Tubo Posteriore / Sport Rear Pipe

ref. AL 0128



GTV 6 81>87

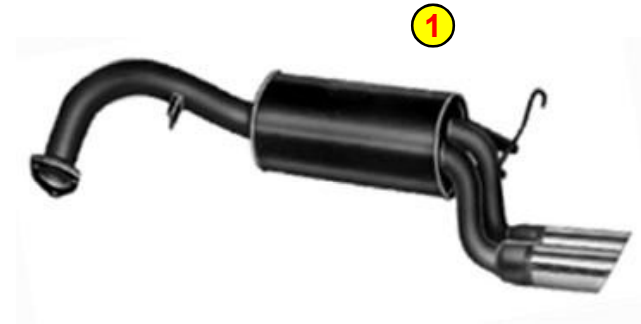

1) Silenziatore Posteriore / Rear Silencer

ref. AL 2427

ALFA ROMEO: montreal - spider - 75

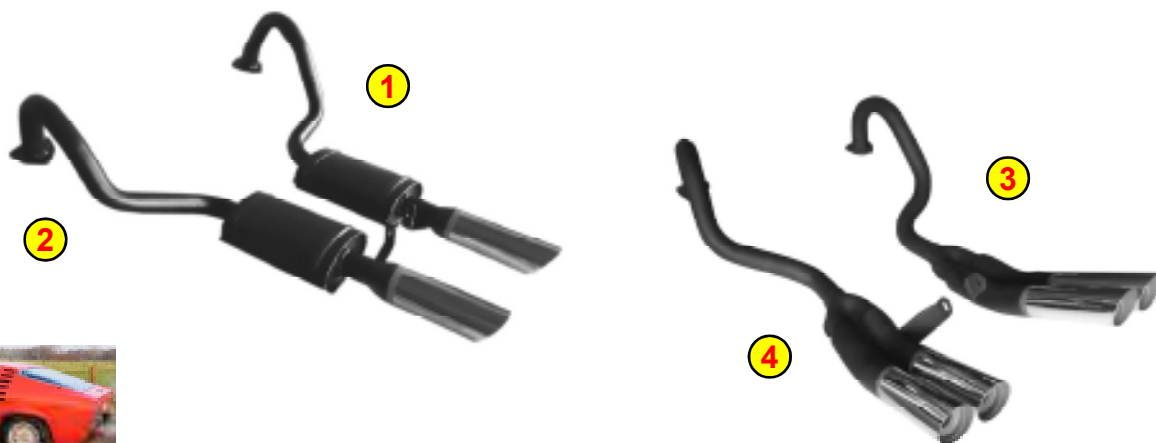

Montreal 70>75

- 1) Sil. Posteriore Dx / R/h Rear Silencer (1 tail pipe)
- 2) Sil. Posteriore Sx / L/h Rear Silencer (1 tail pipe)
- 3) Sil. Posteriore Dx / R/h Rear Silencer (2 tail pipe)
- 4) Sil. Posteriore Sx / L/h Rear Silencer (2 tail pipe)

ref. AL 1927
ref. AL 1937
ref. AL 1928
ref. AL 1938



Spider 1.3 - 1.6 - 1750 - 2.0 63>85

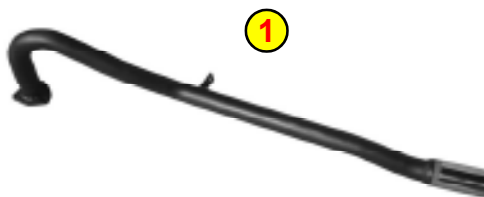

- 1) Tubo Posteriore / Sport Rear Pipe

ref. AL 0928



Spider 1.6 - 2.0 86>92
Spider 2.0 Cat 87>94

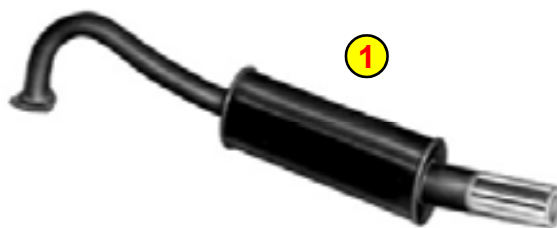

- 1) Silenziatore Posteriore / Rear Silencer

ref. AL 1237



75 2.5 V6 Quadrigoglio Oro / Milano 85>92
75 3.0 V6 America 85>92



- 1) Silenziatore Centrale / Centre Silencer
- 2) Silenziatore Posteriore / Rear Silencer (3/88>)

ref. AL 4165
ref. AL 4167

BUGATTI: eb 110



EB 110 91>95



- | | | |
|---|-----|--------------|
| 1) Silenziatore / Silencer (O.E. style) | --- | ref. BU 0100 |
| 2) Silenziatore / Silencer (Sport) | --- | ref. BU 0120 |

DE TOMASO: deauville - longchamp - mangusta



Deauville 1° Serie 73>88

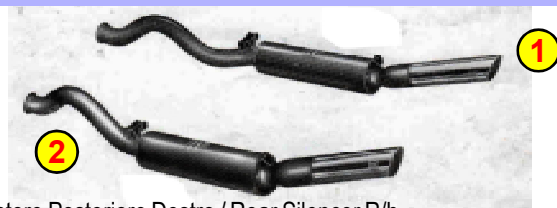

- | | | |
|---|-----|--------------|
| 1) Silenziatore Posteriore Destro / Rear Silencer R/h | --- | ref. DE 0727 |
| 2) Silenziatore Posteriore Sinistro / Rear Silencer L/h | --- | ref. DE 0737 |

Gli impianti 1°serie erano assemblati in linea di montaggio e sono quindi necessari adattamenti.

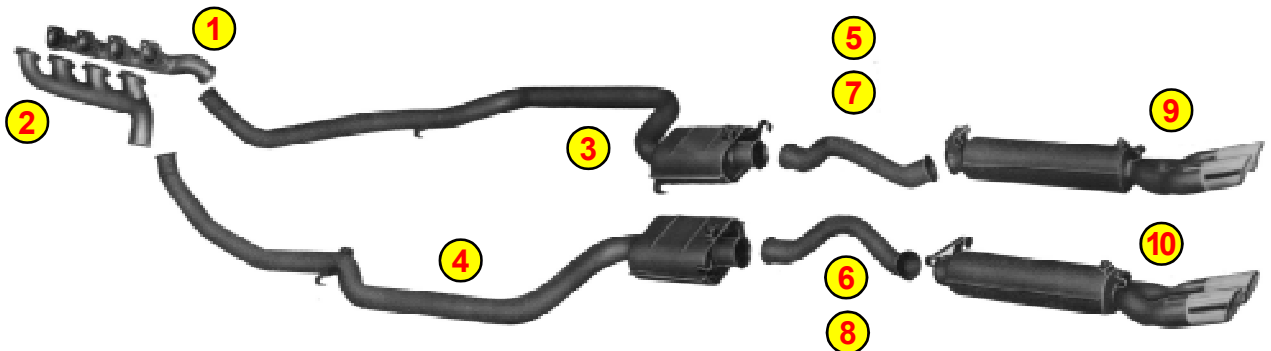

Deauville 2° - 3° Serie 73>88
Longchamp 1° - 2° Serie 73>88



- | | | |
|--|-----|--------------|
| 1) Collettore Destro / R/h Manifold | --- | ref. DE 0821 |
| 2) Collettore Sinistro / L/h Manifold | --- | ref. DE 0831 |
| 3) Silenziatore Centrale Destro / Centre Silencer R/h | --- | ref. DE 0825 |
| 4) Silenziatore Centrale Sinistro / Centre Silencer L/h | --- | ref. DE 0835 |
| 5) Tubo Intermedio Destro/Centre Pipe R/h (Deauville) | --- | ref. DE 0826 |
| 6) Tubo Intermedio Sinistro/Centre Pipe L/h (Deauville) | --- | ref. DE 0836 |
| 7) Tubo Intern. Destro/Centre Pipe R/h (Longchamp) | --- | ref. DE 0926 |
| 8) Tubo Intern. Sinistro / Centre Pipe L/h (Longchamp) | --- | ref. DE 0936 |
| 9) Silenziatore Posteriore Destro / Rear Silencer R/h | --- | ref. DE 0827 |
| 10) Silenziatore Posteriore Sinistro / Rear Silencer L/h | --- | ref. DE 0837 |



Mangusta 66>70

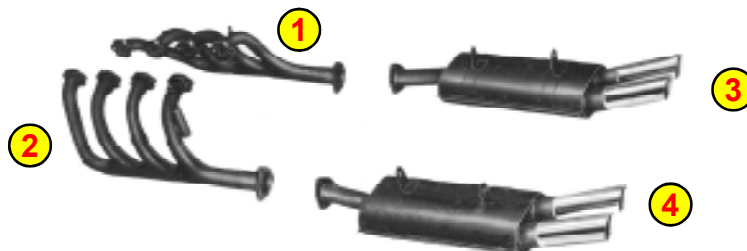

- | | | |
|---|-----|--------------|
| 1) Collettore Destro / R/h Manifold | --- | ref. DE 0121 |
| 2) Collettore Sinistro / L/h Manifold | --- | ref. DE 0131 |
| 3) Silenziatore Posteriore Destro / Rear Silencer R/h | --- | ref. DE 0127 |
| 4) Silenziatore Posteriore Sinistro / Rear Silencer L/h | --- | ref. DE 0137 |

DE TOMASO: pantera



Pantera Coupé 69>70



- | | | |
|--|-----------|--------------|
| 1) Posteriore Destro / Rear Silencer R/h | 10001/3 A | ref. DE 0227 |
| 2) Posteriore Sinistro / Rear Silencer L/h | 10002/4 A | ref. DE 0237 |



Pantera GT 2° Serie 70>72



- | | | |
|--|---------|--------------|
| 1) Collettore Destro / R/h Manifold | 10021 A | ref. DE 0321 |
| 2) Collettore Sinistro / L/h Manifold | 10022 A | ref. DE 0331 |
| 3) Posteriore Destro / Rear Silencer R/h | 10005 A | ref. DE 0327 |
| 4) Posteriore Sinistro / Rear Silencer L/h | 10006 A | ref. DE 0337 |

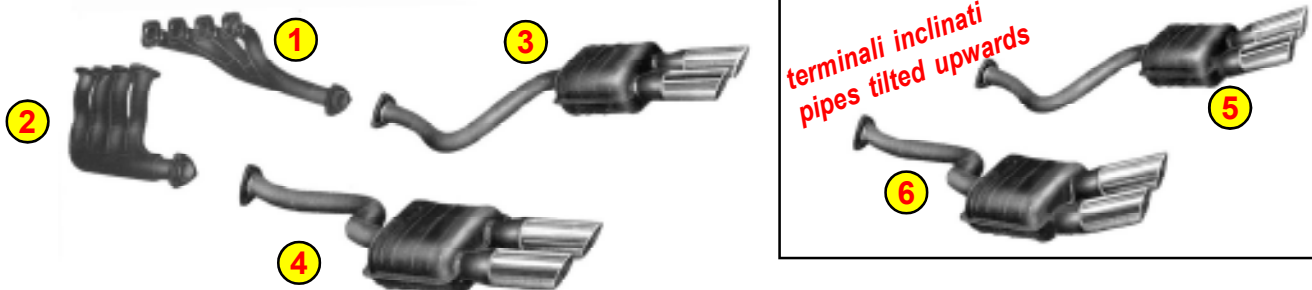

Pantera L 3° Serie (72>91)



- | | | |
|---|---------|--------------|
| 1) Collettore Destro / R/h Manifold | 10023 A | ref. DE 0421 |
| 2) Collettore Sinistro / L/h Manifold | 10024 A | ref. DE 0431 |
| 3) Posteriore Destro / Rear Silencer R/h (original style) | 10007 A | ref. DE 0427 |
| 4) Posteriore Sinistro / Rear Silencer L/h (original style) | 10008 A | ref. DE 0437 |
| 5) Posteriore Destro / Rear Silencer R/h (inclined) | 10007 A | ref. DE 0447 |
| 6) Posteriore Sinistro / Rear Silencer L/h (inclined) | 10008 A | ref. DE 0457 |



Pantera GTS (72>91)
Pantera GT5-5S (72>91)

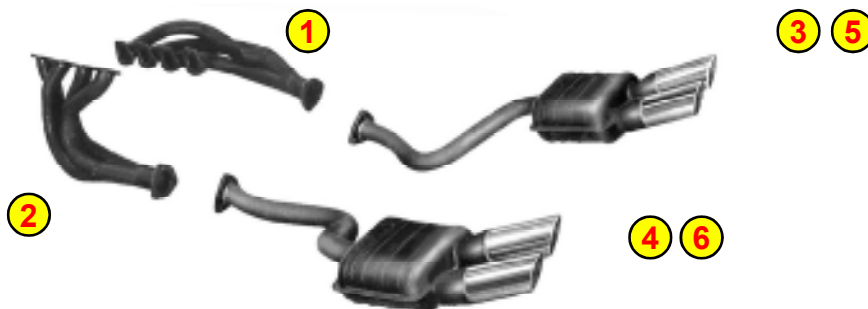

- | | | |
|--|---------|--------------|
| 1) Collettore Destro / R/h Manifold | 10025 A | ref. DE 0521 |
| 2) Collettore Sinistro / L/h Manifold | 10026 A | ref. DE 0531 |
| 3) Silenziatore Destro / Silencer R/h (GTS) | 10009 A | ref. DE 0527 |
| 4) Silenziatore Sinistro / Silencer L/h (GTS) | 10010 A | ref. DE 0537 |
| 5) Silenziatore Destro / Silencer R/h (GT5-5S) | 10009 B | ref. DE 0627 |
| 6) Silenziatore Sinistro / Silencer L/h (GT5-5S) | 10010 B | ref. DE 0637 |

FERRARI: dino 206 - 246

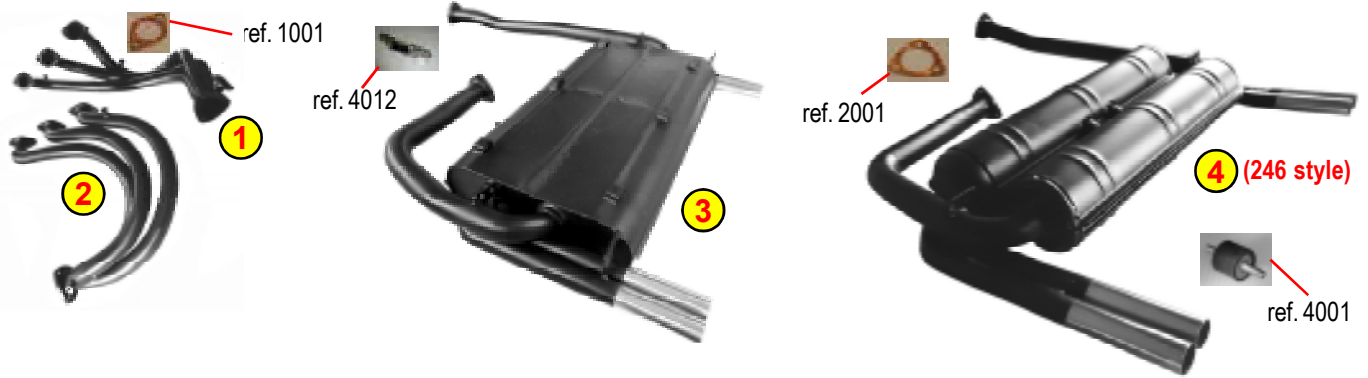

Dino 206 GT (2000 cc) 68>69



- | | | |
|---|----------|--------------|
| 1) Collettore Anteriore / Front Manifold | oe 20422 | ref. FR 1581 |
| 2) Collettore Posteriore / Rear Manifold | oe 20421 | ref. FR 1591 |
| 3) Silenziatore ad 1 cassa / Silencer with 1 box | oe 20393 | ref. FR 1580 |
| 4) Silenziatore a 2 casse / Silencer with 2 boxes | oe 20393 | ref. FR 1510 |

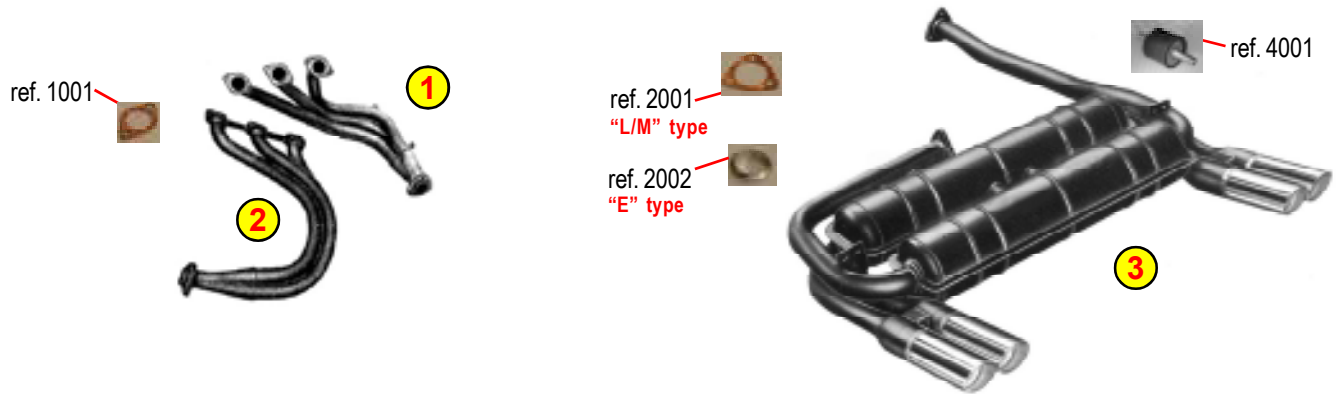

Dino 246 GT (L type - ch 404>1116) 69>70

FLANGIA PIANA / FLAT FLANGE



- | | | |
|--|-----------|--------------|
| 1) Collettore Anteriore / Front Manifold | oe FE/014 | ref. FR 1501 |
| 2) Collettore Posteriore / Rear Manifold | oe FE/015 | ref. FR 1511 |
| 3) Silenziatore / Silencer | oe FE/0S | ref. FR 1500 |

Dino 246 GT (M type-ch 1118>2130) 70>71

FLANGIA PIANA / FLAT FLANGE



- | | | |
|--|-----------|--------------|
| 1) Collettore Anteriore / Front Manifold | oe 20490 | ref. FR 1601 |
| 2) Collettore Posteriore / Rear Manifold | oe 20491 | ref. FR 1611 |
| 3) Silenziatore / Silencer | oe FE/013 | ref. FR 1600 |

Dino 246 GT-GTS (E type-ch 2132>8518) 71>74

FLANGIA SVASATA / FLAVET FLANGE



- | | | |
|--|----------|--------------|
| 1) Collettore Anteriore / Front Manifold | oe 20545 | ref. FR 1701 |
| 2) Collettore Posteriore / Rear Manifold | oe 20544 | ref. FR 1711 |
| 3) Silenziatore / Silencer | oe 20518 | ref. FR 1700 |

Dino 246 GT-GTS (E type USA) 71>74

FLANGIA SVASATA / FLAVET FLANGE



- | | | |
|--|----------|--------------|
| 1) Front Manifold (without insulation) | oe 20481 | ref. FR 1741 |
| 2) Rear Manifold (without insulation) | oe 20480 | ref. FR 1751 |
| 3) Silenziatore / Silencer | oe 20518 | ref. FR 1740 |

FERRARI: 208 - 208 turbo

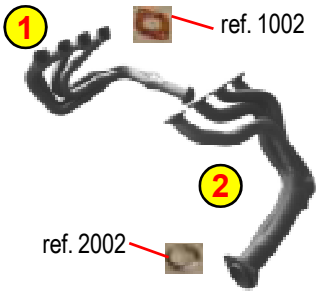

Dino 208 GT4 2+2 75>80

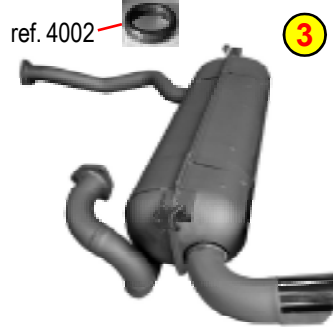

- 1) Collettore Anteriore / Front Manifold
- 2) Collettore Posteriore / Rear Manifold
- 3) Silenziatore 1 uscita / Silencer (1 Tail Pipe)
- 4) Silenziatore Sport / Sport Silencer (4 Tail Pipes)

108433
108434
108480
(108480)

ref. FR 1801
ref. FR 1811
ref. FR 1880
ref. FR 1800

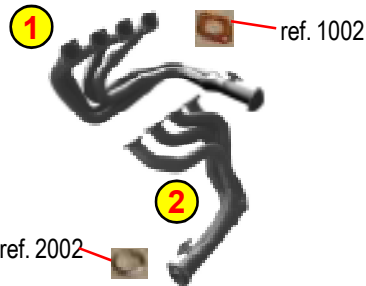

208 GTB - GTS 80>82



- 1) Collettore Anteriore / Front Manifold
- 2) Collettore Posteriore / Rear Manifold
- 3) Silenziatore 1 uscita / Silencer (1 tail pipe)
- 4) Silenziatore Sport / Sport Silencer (4 Tail Pipes)

114078
114079
114099
(114099)

ref. FR 2101
ref. FR 2111
ref. FR 2180
ref. FR 2100

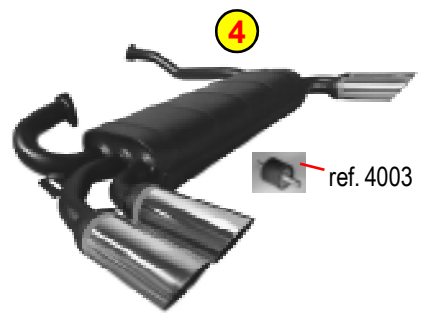

208 GTB - GTS TURBO 82>86



- 1) Collettore Anteriore / Front Manifold
- 2) Collettore Posteriore / Rear Manifold
- 3) Silenziatore / Silencer
- 4) Silenziatore Sport / Sport Silencer (INOX)

120114
117964
118113
119523

ref. FR 3121
ref. FR 3131
ref. FR 3100
ref. FR 3120

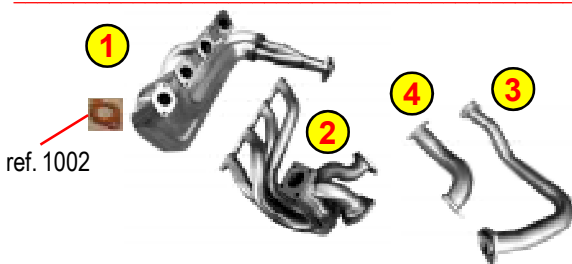

GTB - GTS TURBO Intercooler 86>89

- 1) Collettore Anteriore / Front Manifold
- 2) Collettore Posteriore / Rear Manifold
- 3) Tubo Intermedio / Inter Pipe
- 4) Tubo dal turbo / Pipe from turbo
- 5) Silenziatore Sport / Sport Silencer (INOX)

120114
117964
120115
117697
119523

ref. FR 3121
ref. FR 3151
ref. FR 3152
ref. FR 3154
ref. FR 3120

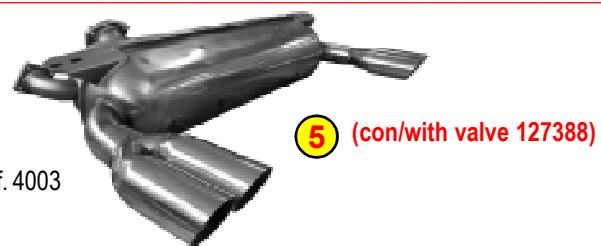

FERRARI: 308 - mondial



308 GT/4 (2+2) 74>80

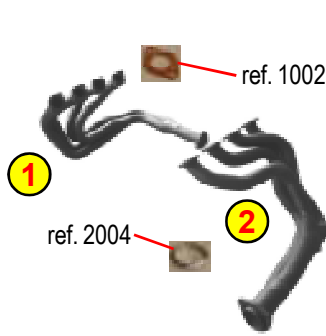

- 1) Collettore Anteriore / Front Manifold
- 2) Collettore Posteriore / Rear Manifold
- 3) Silenziatore Sport / Sport Silencer

106593
106594
106593



ref. FR 1901
ref. FR 1911
ref. FR 1900



308 GTB - GTS carburatori 75>81

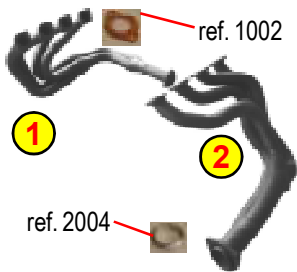

- 1) Collettore Anteriore / Front Manifold
- 2) Collettore Posteriore / Rear Manifold
- 3) Silenziatore / Silencer (1 Tail Pipe)
- 4) Silenziatore Sport / Sport Silencer

106593
106594
108968/113987
(108968/113987)

ref. FR 1901
ref. FR 1911
ref. FR 2080
ref. FR 2020

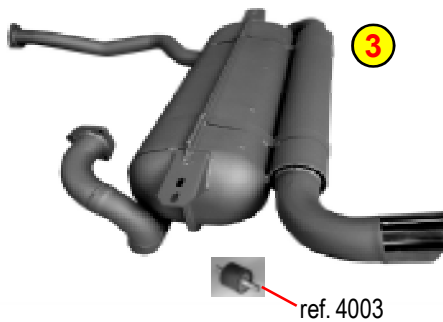

308 GTBi - GTSi - Mondial 8 (2 Valvole) 81>82



- 1) Collettore Anteriore / Front Manifold
- 2) Collettore Posteriore / Rear Manifold
- 3) Silenziatore Sport / Sport Silencer

108326
116318
113251

ref. FR 1901
ref. FR 1911
ref. FR 2620



308 GTBi - GTSi (Quattrovalvole) 82>85 Mondial + Cabrio (Quattrovalvole) 82>85

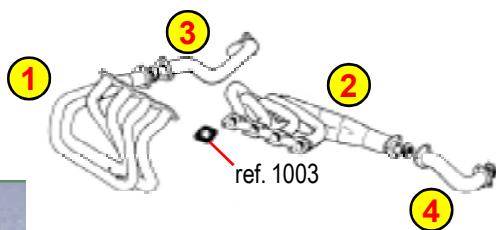

- 1) Collettore Anteriore / Front Manifold
- 2) Collettore Posteriore / Rear Manifold
- 3) Tubo Intermedio Destro / Centre Pipe R/h
- 4) Tubo Intermedio Sinistro / Centre Pipe L/h
- 5) Silenziatore Sport / Sport Silencer

118155
118156/129409
118157
118158
118353/127942

ref. FR 3201
ref. FR 3211
ref. FR 3202
ref. FR 3212
ref. FR 2620

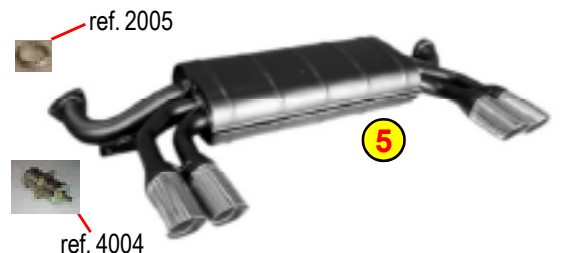

FERRARI: 308 - mondial USA MODELS

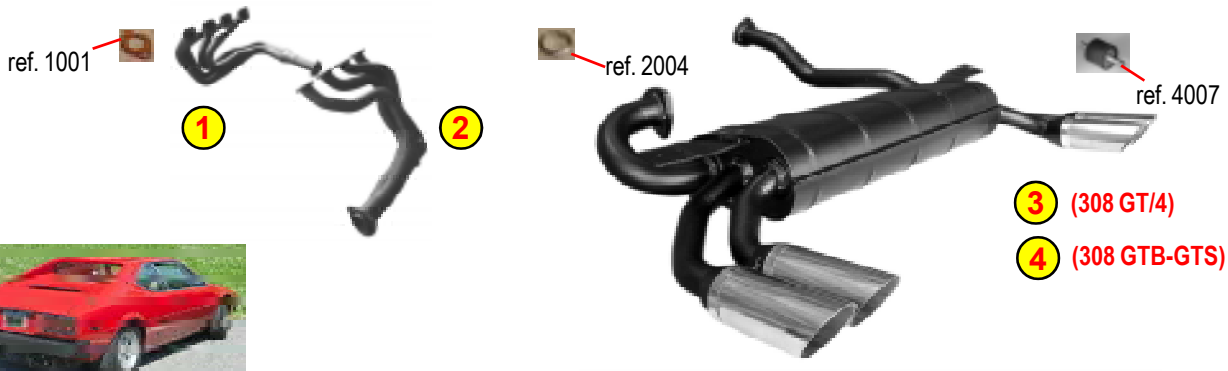

308 GT/4 (2+2) 74>80
[EUROPEAN MODEL FOR USA](#)



1) Front Manifold (without insulation)	108212	ref. FR 1941
2) Rear Manifold (without insulation)	108213	ref. FR 1951
3) Silenziatore Sport / Sport Silencer	108211	ref. FR 1940

308 GTB - GTS 80
[EUROPEAN MODEL FOR USA](#)



1) Front Manifold (without insulation)	108212	ref. FR 1941
2) Rear Manifold (without insulation)	108213	ref. FR 1951
4) Silenziatore Sport / Sport Silencer	(108211)	ref. FR 2040



308 GTB - GTS 81>82
Mondial 8 81>82



(European Model For USA)
replaces also inter silencers (111583)

1) Silenziatore Sport / Sport Silencer	(111901)	ref. FR 2660
--	----------	--------------



308 GTBi - GTSi - Mondial 8 (2 v. Cat) 81>82
308 GTBi - GTSi Quattrovalvole 82>83
(with 2 Cat. Converters)

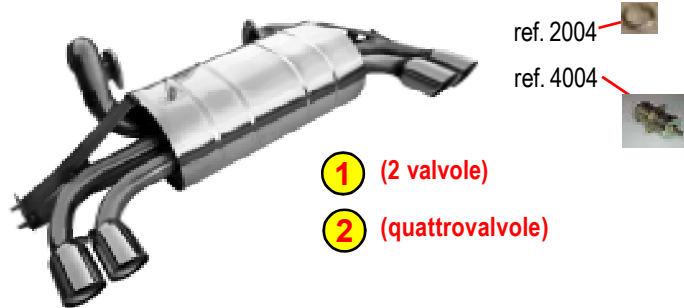

- 1) (2 valvole)
- 2) (quattrovalvole)

1) Silenziatore Sport / Sport Silencer	114683	ref. FR 3350
2) Silenziatore Sport / Sport Silencer	118824	ref. FR 3360



308 GTBi - GTSi (Quattrovalvole) 83>85
(with 1 Cat. Converter)



1) Catalizzatore / C. Converter	121385	ref. FR 3023
2) Tronchetto / Test Pipe	126534	ref. FR 3024
3) Silenziatore Sport / Sport Silencer	121383	ref. FR 3060

FERRARI: 328 - mondial

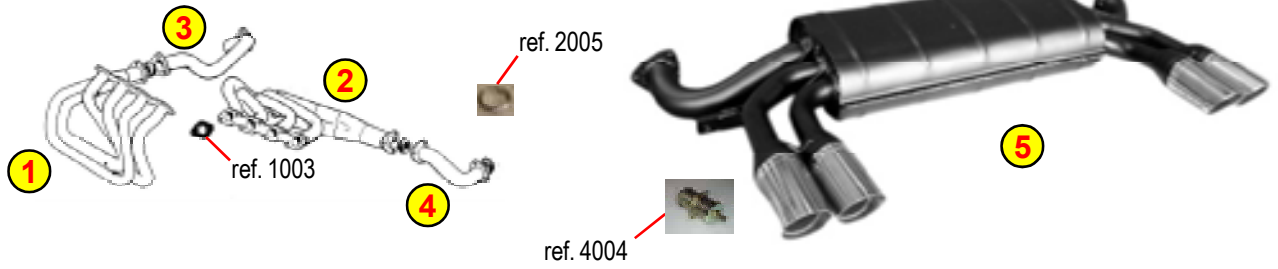

328 GTB - GTS 85>89
Mondial 3.2 GTB - GTS 85>89

1) Collettore Anteriore / Front Manifold	118155	ref. FR 3201
2) Collettore Posteriore / Rear Manifold	118156/129409	ref. FR 3211
3) Tubo Intermedio Destro / Centre Pipe R/h	118157	ref. FR 3202
4) Tubo Intermedio Sinistro / Centre Pipe L/h	118158	ref. FR 3212
5) Silenziatore Sport / Sport Silencer	131954	ref. FR 3220

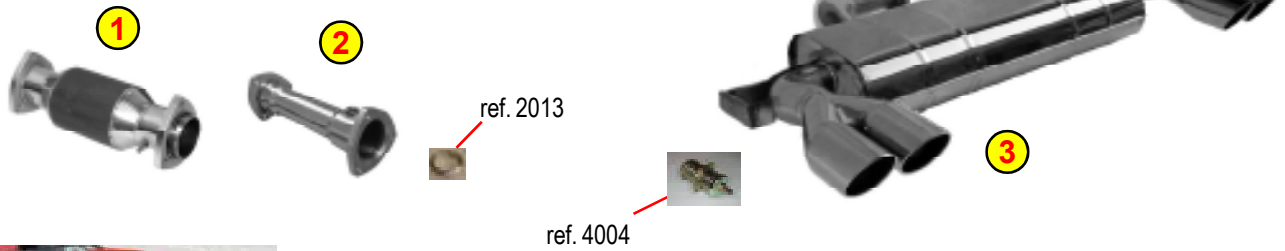

328 GTB - GTS Cat. 85>89
Mondial + Cabrio (Quattrovalvole) Cat. 83>85
Mondial 3.2 GTB - GTS Cat. 85>89

1) Catalizzatore / C. Converter	121385	ref. FR 3023
2) Tubo Sost. Cat. / Test Pipe	126534	ref. FR 3024
3) Silenziatore Sport / Sport Silencer (inox)	131954	ref. FR 3160

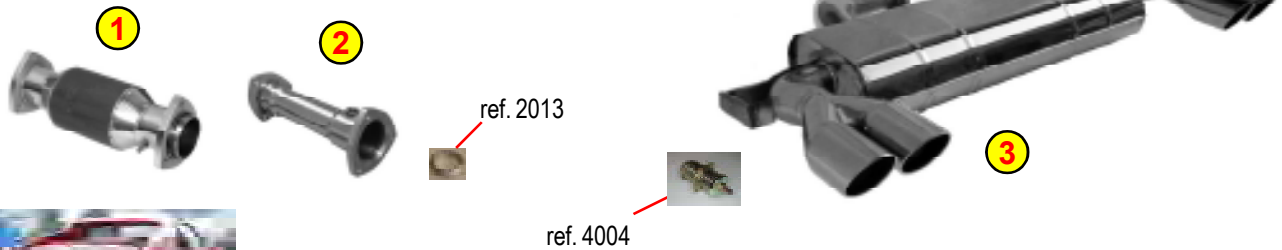

USA model

328 GTBi - GTSi 85>89
Mondial 3.2 GTB - GTS 85>89

1) Catalizzatore / C. Converter	121385	ref. FR 3023
2) Tronchetto / Test Pipe	126534	ref. FR 3024
4) Silenziatore Sport / Sport Silencer	128524	ref. FR 3050

FERRARI: 348 - mondial t - 355

BENDATO / WRAPPED



ref. 2005

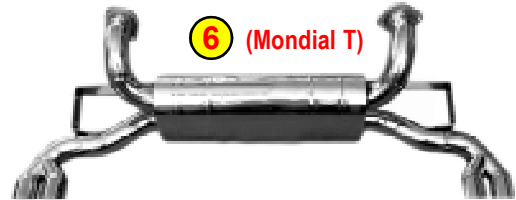

348 TB - TS - Spider 89>94
Mondial T - T Cabrio 89>94

- | | | |
|--|--------|--------------|
| 1) Collettore Dx / R/h Manifold | 136275 | ref. FR 4321 |
| 2) Collettore Sx / L/h Manifold | 136276 | ref. FR 4331 |
| 3) Catalizzatore / C.Converter (2 pcs required) | 160506 | ref. FR 4323 |
| 4) Tubo Sost. Cat / Test Pipes (2 pcs required) | 141006 | ref. FR 4324 |
| 5) Silenziatore Sport / Sport Silencer (348) | 157351 | ref. FR 4320 |
| 6) Silenziatore Sport / Sport Silencer (Mondial T) | 138887 | ref. FR 4380 |

BENDATO / WRAPPED

ref. 1006



ref. 2005

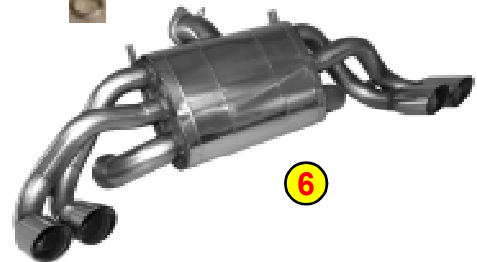

355 Berlinetta - GTS - F1 - Spider 94>99
Injection 2.7

- | | | |
|--|---------------|--------------|
| 1) Collettore Dx / R/h Manifold | 180293 | ref. FR 4621 |
| 2) Collettore Sx / L/h Manifold | 180294 | ref. FR 4631 |
| 3) Catalizzatore Dx / R/h C.Converter | 178292 | ref. FR 4623 |
| 4) Catalizzatore Sx / C.Converter L/h | 178291 | ref. FR 4633 |
| 5) Tubi Sost. Cat (Dx+Sx) / Test Pipes (R/h+L/h) | -- | ref. FR 4684 |
| 6) Silenziatore Sport / Sport Silencer | 169913/157403 | ref. FR 4620 |

BENDATO / WRAPPED

ref. 1006

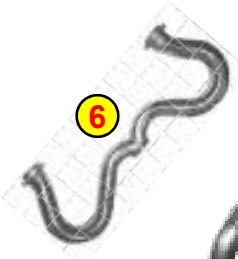

ref. 2005



355 Berlinetta - GTS - F1 - Spider 96>99
Injection 5.2

- | | | |
|--|---------------|--------------|
| 1) Collettore Dx / R/h Manifold | 179947 | ref. FR 4641 |
| 2) Collettore Sx / L/h Manifold | 179948 | ref. FR 4651 |
| 3) Catalizzatore Dx / R/h C.Converter | 176205 | ref. FR 4623 |
| 4) Catalizzatore Sx / C.Converter L/h | 176206 | ref. FR 4633 |
| 5) Tubi Sost. Cat (Dx+Sx) / Test Pipes (R/h+L/h) | -- | ref. FR 4684 |
| 6) Tubo By-Pass | 168977 | ref. FR 4626 |
| 7) Silenziatore Sport / Sport Silencer | 168988/168568 | ref. FR 4620 |

FERRARI: 360 - 430 - 288 GTO

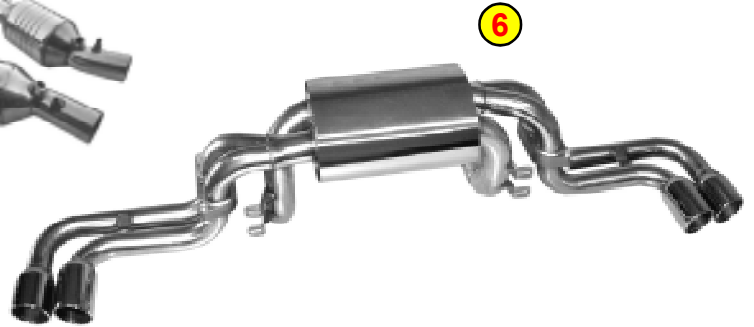
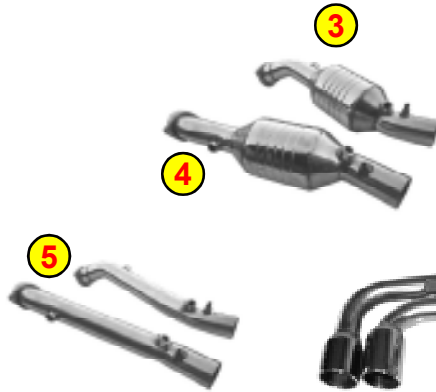
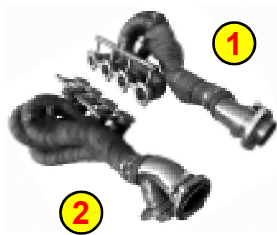

360 Modena - Spider 99>05

1) Collettori Destro - R/h Manifold	178438	ref. FR 4721
2) Collettore Sinistro - L/h Manifold	178437	ref. FR 4731
3) Catalizzatori Destro / R/h C.Converter	180019	ref. FR 4723
4) Catalizzatore Sinistro / L/h C.Converter	180020	ref. FR 4733
5) Tubi Sost.Cat (Dx+Sx) / Test Pipes (R/h+L/h)	---	ref. FR 4784
6) Silenziatore Sport / Sport Silencer	174089	ref. FR 4720

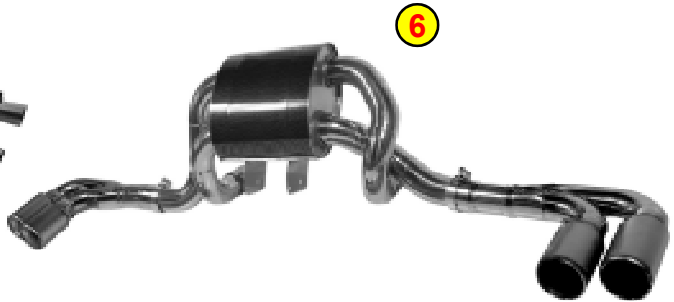
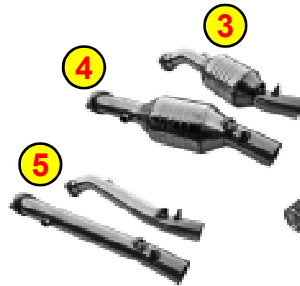
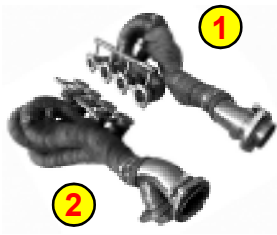

F430 Berlinetta - Spider 04>

1) Collettori Destro - R/h Manifold	247593	ref. FR 4921
2) Collettore Sinistro - L/h Manifold	247594	ref. FR 4931
3) Catalizzatori Destro / R/h C.Converter	216241	ref. FR 4923
4) Catalizzatore Sinistro / L/h C.Converter	216242	ref. FR 4933
5) Tubi Sost.Cat (Dx+Sx) / Test Pipes (R/h+L/h)	---	ref. FR 4984
6) Silenziatore Sport / Sport Silencer (inox)	239880	ref. FR 4920

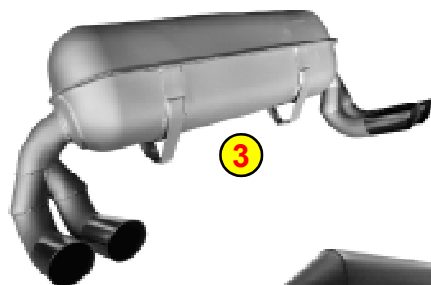
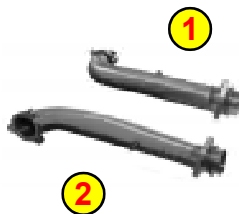

GTO (288) 84>

1) Tubo intermedio dx / R/h inter pipe	123387	ref. FR 5124
2) Tubo intermedio sx / L/h inter pipe	123388	ref. FR 5134
3) Silenziatore / Silencer (O.E. style)	123426	ref. FR 3700
4) Silenziatore Racing /Racing Silencer (2 conical tail p.) (123426)		ref. FR 3780
5) Silenziatore Sport / Sport Silencer (4 tail pipes) (123426)		ref. FR 3720

FERRARI: F40

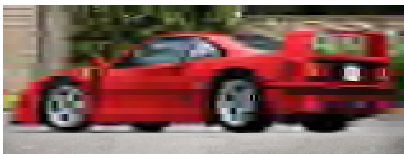
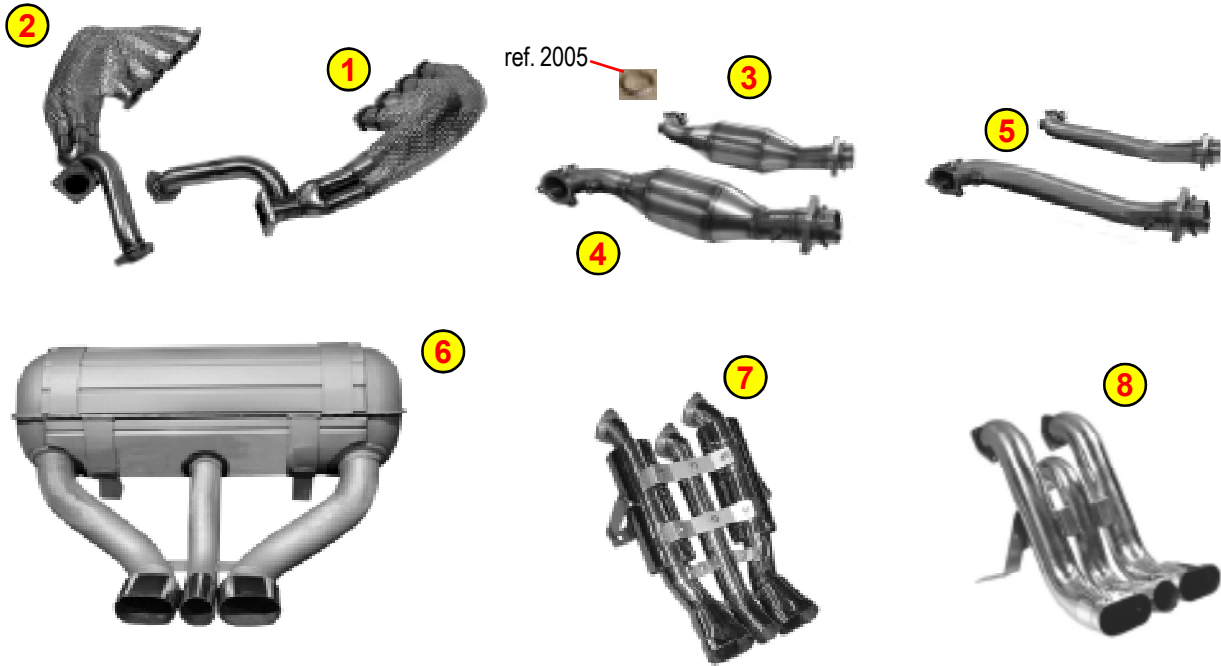

F40 87>92
CATALIZZATA (with C.Converters)

- | | | |
|---|--------|--------------|
| 1) Collettori Destro / R/h Manifolds | 142576 | ref. FR 5021 |
| 2) Collettore Sinistro / L/h Manifold | 142575 | ref. FR 5031 |
| 3) Catalizzatore Destro / R/h C. Converter | 142524 | ref. FR 5023 |
| 4) Catalizzatore Sinistro / L/h C. Converter | 142525 | ref. FR 5033 |
| 5) Tubi Sostit. Cat / Test Pipes (R/h+L/h) | --- | ref. FR 5084 |
| 6) Silenziatore / Silencer | 142527 | ref. FR 5000 |
| 7) Silenziatore Sport / Sport Silencer | --- | ref. FR 5020 |
| 8) Posteriore Racing / Racing Tail Pipes | --- | ref. FR 5030 |

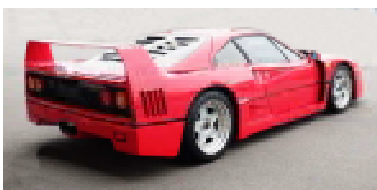
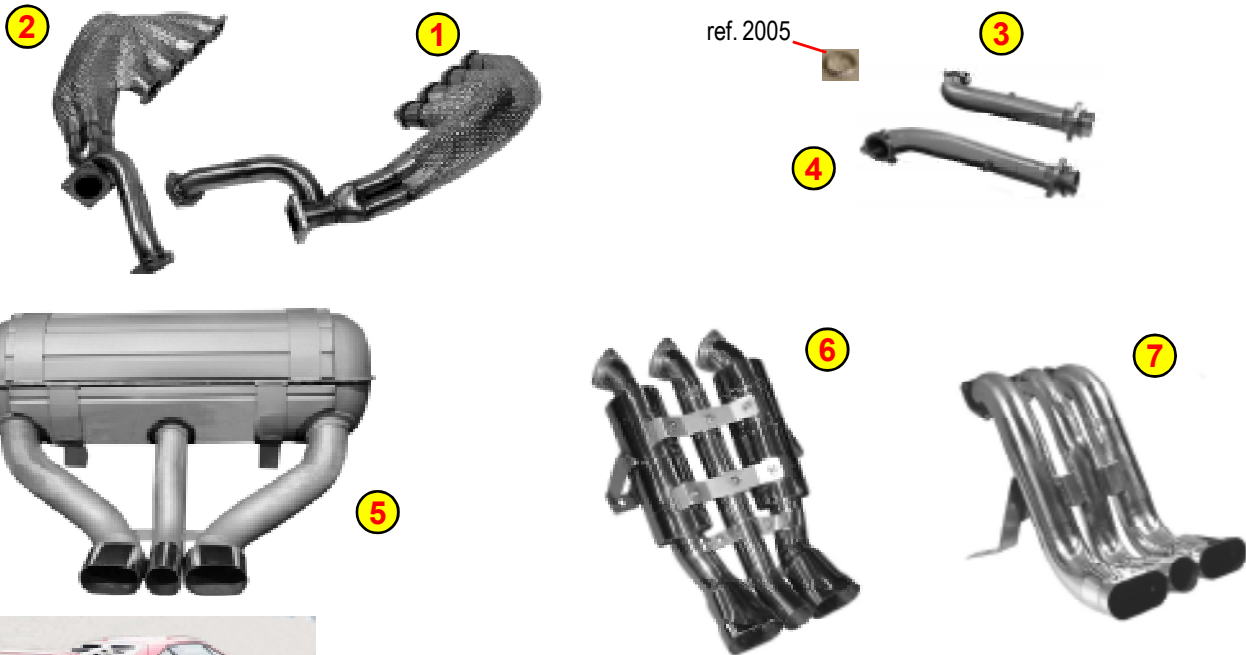

F40 87>92
NON Catalizzata (w/h C.Converters)

- | | | |
|---|--------|--------------|
| 1) Collettori Destro / R/h Manifolds | 135073 | ref. FR 5121 |
| 2) Collettore Sinistro / L/h Manifold | 135072 | ref. FR 5131 |
| 3) Tubo Intermedio Destro / R/h Inter Pipe | 123387 | ref. FR 5124 |
| 4) Tubo Intermedio Sinistro / L/h Inter Pipe | 123388 | ref. FR 5134 |
| 5) Silenziatore / Silencer | 136399 | ref. FR 5100 |
| 6) Silenziatore Sport / Sport Silencer | --- | ref. FR 5120 |
| 7) Posteriore Racing / Racing Tail Pipes | --- | ref. FR 5130 |

FERRARI: 212 - 250 europa - 250 gt boano/ellena



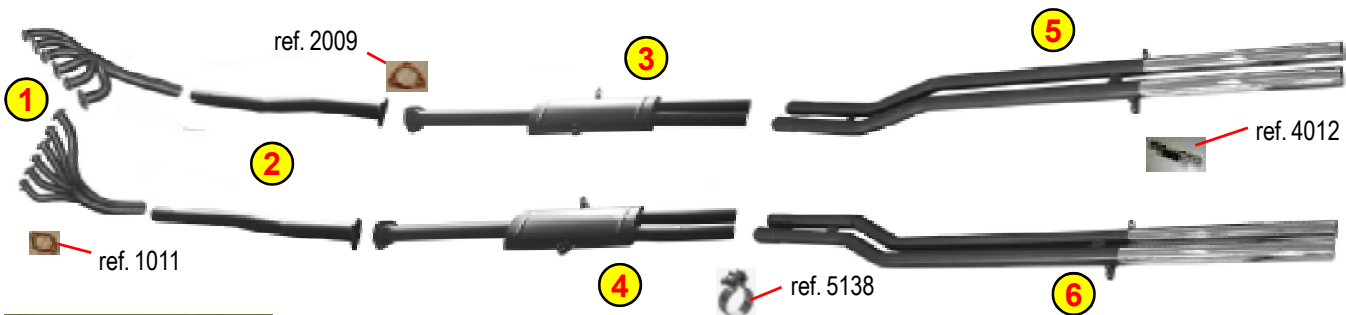

1) Centrale Destro / Centre Silencer R/h	---	ref. FR 6025
2) Centrale Sinistro / Centre Silencer L/h	---	ref. FR 6035
3) Posteriore Destro / Rear Pipes R/h	---	ref. FR 6028
4) Posteriore Sinistro / Rear Pipes L/h	---	ref. FR 6038

212 Inter (LWB-2600) 51>53 (***)

1) Collettori (Dx+Sx) / Manifolds (R/h+L/h)	---	ref. FR 0181
2) Tubi intermedi (Dx+Sx) / Inter Pipes (R/h+L/h)	---	ref. FR 0184
3) Centrale Destro / Centre Silencer R/h	---	ref. FR 0143
4) Centrale Sinistro / Centre Silencer L/h	---	ref. FR 0153
5) Posteriore Destro / Rear Pipes R/h	---	ref. FR 0148
6) Posteriore Sinistro / Rear Pipes L/h	---	ref. FR 0158

250 Europa (LWB-2800) 1953 (***)

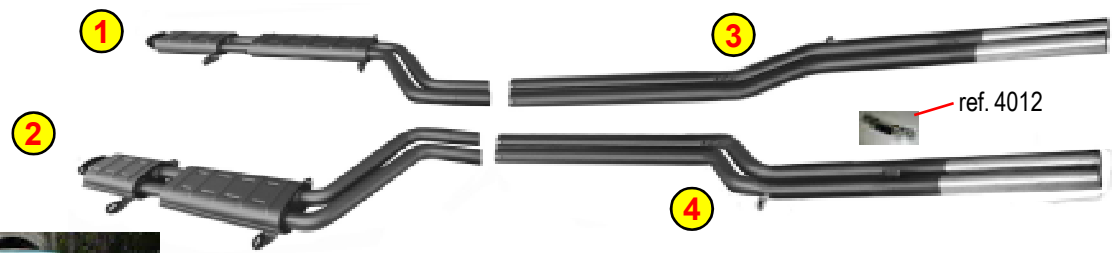
1) Centrale Destro / Centre Silencer R/h	---	ref. FR 0145
2) Centrale Sinistro / Centre Silencer L/h	---	ref. FR 0155
3) Posteriore Destro / Rear Silencer R/h	---	ref. FR 0147
4) Posteriore Sinistro / rear Silencer L/h	---	ref. FR 0157

250 Europa GT (LWB-2600) 54>58 (***)



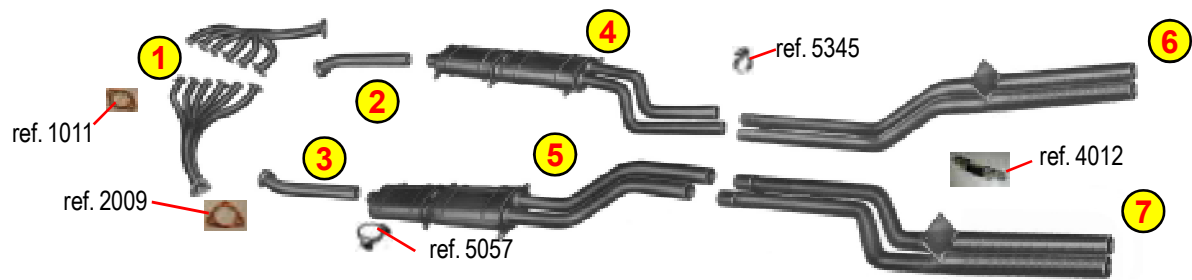

1) Collettori (Dx+Sx) / Manifolds (R/h+L/h)	---	ref. FR 3981
2) Tubo intermedio Dx / Inter Pipe R/h	---	ref. FR 3922
3) Tubo intermedio Sx / Inter Pipe L/h	---	ref. FR 3932
4) Centrale Destro / Centre Silencer R/h	---	ref. FR 3925
5) Centrale Sinistro / Centre Silencer L/h	---	ref. FR 3935
6) Posteriore Destro / Rear Silencer R/h	---	ref. FR 3928
7) Posteriore Sinistro / rear Silencer L/h	---	ref. FR 3938

250 GT Boano & Ellena (LWB-2600) 57>60 (***)

*** Vetture realizzate completamente a mano; sono possibili differenze che richiedono un adattamento / Handmade cars; some modification may be required to the exhaust system during fitting.

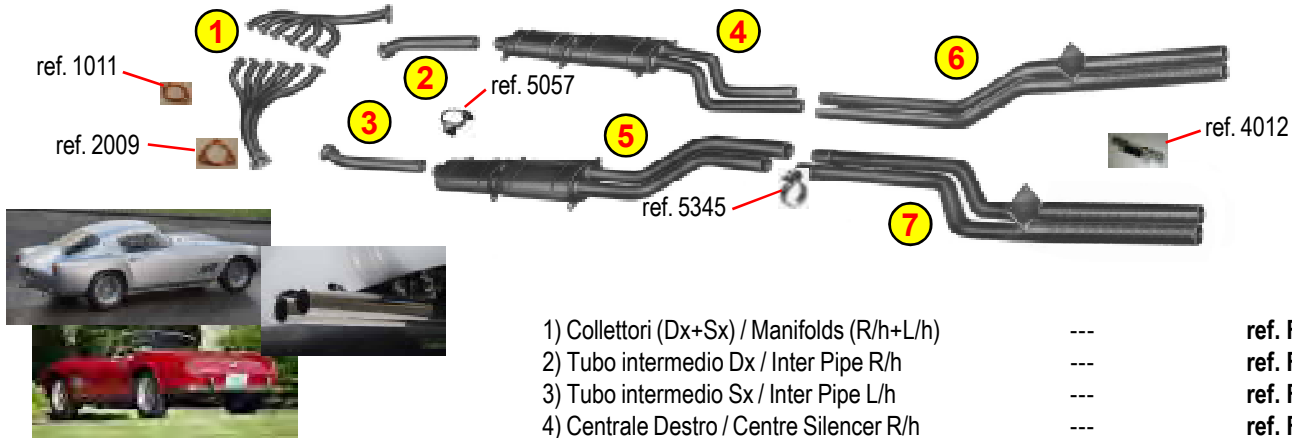
FERRARI: 250 tdf - 250 spider california lwb - 250 gt - 250 swb competizione



250 GT Tour De France (LWB-2600) 55>59 (***)
 250 Spider California (LWB -2600) 57>60 (***)

- | | | |
|--|-----|--------------|
| 1) Collettori (Dx+Sx) / Manifolds (R/h+L/h) | --- | ref. FR 2881 |
| 2) Tubo intermedio Dx / Inter Pipe R/h | --- | ref. FR 2822 |
| 3) Tubo intermedio Sx / Inter Pipe L/h | --- | ref. FR 2832 |
| 4) Centrale Destro / Centre Silencer R/h | --- | ref. FR 2825 |
| 5) Centrale Sinistro / Centre Silencer L/h | --- | ref. FR 2835 |
| 6) Tubo Posteriore Dx / Rear Pipe R/h (standard style) | --- | ref. FR 2807 |
| 7) Tubo Posteriore Sx / Rear Pipe L/h (standard style) | --- | ref. FR 2817 |

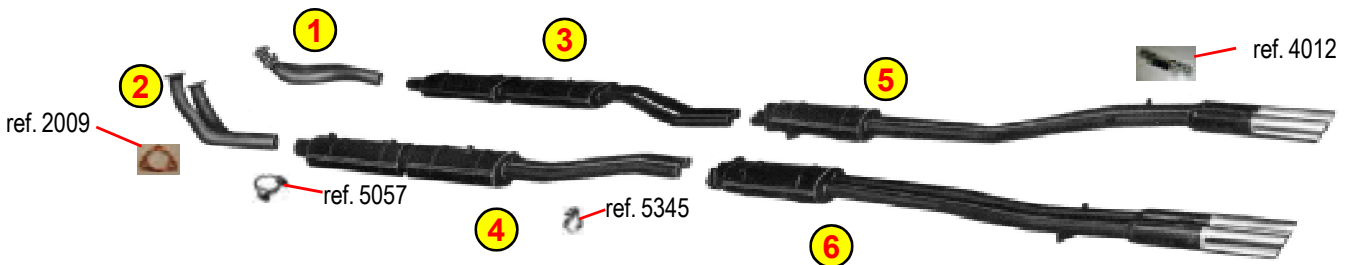

250 GT Coupè Pininfarina (LWB-2600) 58>60 (***)

- | | | |
|--|-----|--------------|
| 1) Tubo intermedio Dx / Inter Pipe R/h | --- | ref. FR 0222 |
| 2) Tubo intermedio Sx / Inter Pipe L/h | --- | ref. FR 0232 |
| 3) Centrale Destro / Centre Silencer R/h | --- | ref. FR 0225 |
| 4) Centrale Sinistro / Centre Silencer L/h | --- | ref. FR 0235 |
| 5) Posteriore Destro / Rear Silencer R/h | --- | ref. FR 0227 |
| 6) Posteriore Sinistro / rear Silencer L/h | --- | ref. FR 0237 |

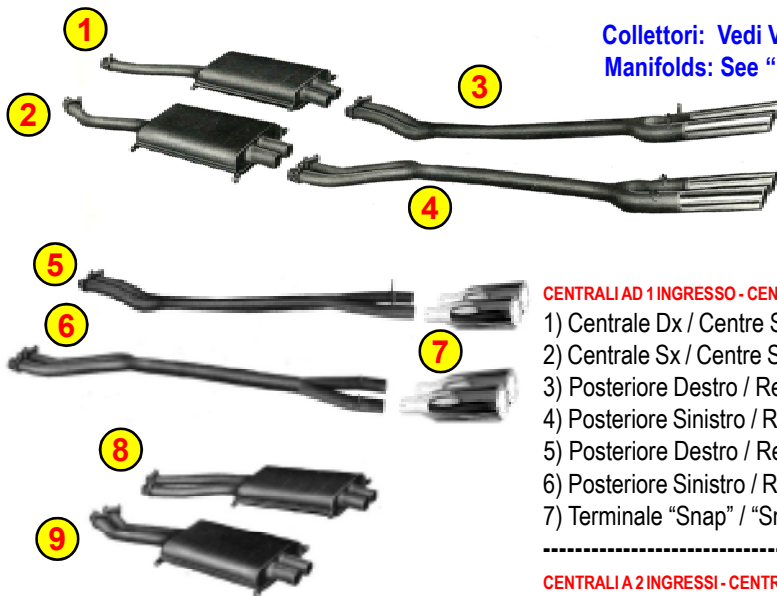

Collettori: Vedi Versioni "STRADALE" - pagina successiva
 Manifolds: See "STRADALE" Models - next page

CENTRALI AD 1 INGRESSO - CENTRE SILENCERS 1 INLET PIPE

- | | | |
|---|-----|----------------|
| 1) Centrale Dx / Centre Silencer R/h | --- | ref. FR 0185/1 |
| 2) Centrale Sx / Centre Silencer L/h | --- | ref. FR 0195/1 |
| 3) Posteriore Destro / Rear Pipes R/h (ANSA LOOK) | --- | ref. FR 0128 |
| 4) Posteriore Sinistro / Rear Pipes L/h (ANSA LOOK) | --- | ref. FR 0138 |
| 5) Posteriore Destro / Rear Pipes R/h (ORIGINAL LOOK) | --- | ref. FR 0187 |
| 6) Posteriore Sinistro / Rear Pipes L/h (ORIGINAL LOOK) | --- | ref. FR 0197 |
| 7) Terminale "Snap" / "Snap" Tail Trim (need 4 pcs) | --- | ref. UN 0199 |

CENTRALI A 2 INGRESSI - CENTRE SILENCERS WITH 2 INLET PIPES

- | | | |
|---|-----|--------------|
| 8) Centrale Dx / Centre Silencer R/h | --- | ref. FR 0185 |
| 9) Centrale Sx / Centre Silencer L/h | --- | ref. FR 0195 |
| 3) Posteriore Destro / Rear Pipes R/h (ANSA LOOK) | --- | ref. FR 0128 |
| 4) Posteriore Sinistro / Rear Pipes L/h (ANSA LOOK) | --- | ref. FR 0138 |
| 5) Posteriore Destro / Rear Pipes R/h (ORIGINAL LOOK) | --- | ref. FR 0187 |
| 6) Posteriore Sinistro / Rear Pipes L/h (ORIGINAL LOOK) | --- | ref. FR 0197 |
| 7) Terminale "Snap" / "Snap" Tail Trim (need 4 pcs) | --- | ref. UN 0199 |

250 GT SWB **COMPETIZIONE** 59>63 (***)

*** Vetture realizzate completamente a mano; sono possibili differenze che richiedono un adattamento / Handmade cars; some modification may be required to the exhaust system during fitting.

FERRARI: 250 swb stradale - 250 swb spider california

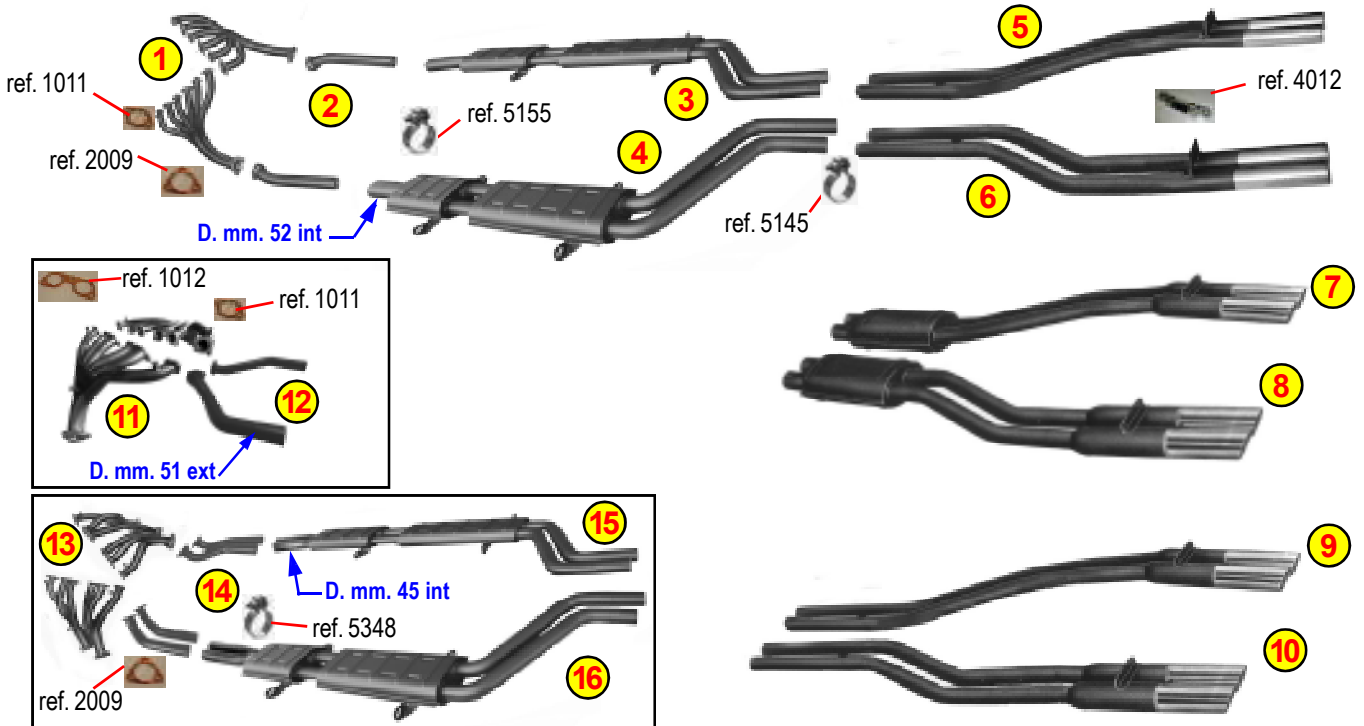

Collettori con 12 Singole Flange e Silenziatore Centrale con singolo ingresso
Manifolds With 12 Single Flanges & Centre Silencer 1 Inlet Pipe

1) Collettori (Dx+Sx) / Manifolds (R/h+L/h)	---	ref. FR 0191
2) Tubi intermedi (Dx+Sx) / Inter pipes (R/h+L/h)	---	ref. FR 0192
3) Centrale Dx / Centre Silencer R/h	---	ref. FR 0165
4) Centrale Sx / Centre Silencer L/h	---	ref. FR 0175
5) Posteriore Dx / Rear Pipes R/h (O.E. style)	---	ref. FR 0168
6) Posteriore Sx / Rear Pipes L/h (O.E. style)	---	ref. FR 0178
7) Posteriore Dx / Rear Silencer R/h (Ansa style)	---	ref. FR 0127
8) Posteriore Sx / Rear Silencer L/h (Ansa style)	---	ref. FR 0137
9) Posteriore Dx / Rear Silencer R/h (Ansa style - no Box)	---	ref. FR 0188
10) Posteriore Sx / Rear Silencer L/h (Ansa style - no Box)	---	ref. FR 0198

Collettori a Flangia Centrale doppia e Silenziatore Centrale con singolo ingresso
Manifolds With Double Center Flange & Centre Silencer 1 Inlet Pipe

11) Collettori (Dx+Sx) / Manifolds (R/h+L/h)	---	ref. FR 0491
12) Tubi intermedi (Dx+Sx) / Inter pipes (R/h+L/h)	---	ref. FR 0492
3) Centrale Dx / Centre Silencer R/h	---	ref. FR 0165
4) Centrale Sx / Centre Silencer L/h	---	ref. FR 0175
5) Posteriore Dx / Rear Pipes R/h (O.E. style)	---	ref. FR 0168
6) Posteriore Sx / Rear Pipes L/h (O.E. style)	---	ref. FR 0178
7) Posteriore Dx / Rear Silencer R/h (Ansa style)	---	ref. FR 0127
8) Posteriore Sx / Rear Silencer L/h (Ansa style)	---	ref. FR 0137
9) Posteriore Dx / Rear Silencer R/h (Ansa style - no Box)	---	ref. FR 0188
10) Posteriore Sx / Rear Silencer L/h (Ansa style - no Box)	---	ref. FR 0198

Collettori Sdoppiati e Silenziatore Centrale con doppio ingresso
Double Manifolds & Centre Silencer with 2 Inlet Pipe

13) Collettori (Dx+Sx) / Manifolds (R/h+L/h)	---	ref. FR 0481
14) Tubi intermedi (Dx+Sx) / Inter pipes (R/h+L/h)	---	ref. FR 0482
15) Centrale Dx / Centre Silencer R/h	---	ref. FR 0125
16) Centrale Sx / Centre Silencer L/h	---	ref. FR 0135
5) Posteriore Dx / Rear Pipes R/h (O.E. style)	---	ref. FR 0168
6) Posteriore Sx / Rear Pipes L/h (O.E. style)	---	ref. FR 0178
7) Posteriore Dx / Rear Silencer R/h (Ansa style)	---	ref. FR 0127
8) Posteriore Sx / Rear Silencer L/h (Ansa style)	---	ref. FR 0137
9) Posteriore Dx / Rear Silencer R/h (Ansa style - no Box)	---	ref. FR 0188
10) Posteriore Sx / Rear Silencer L/h (Ansa style - no Box)	---	ref. FR 0198

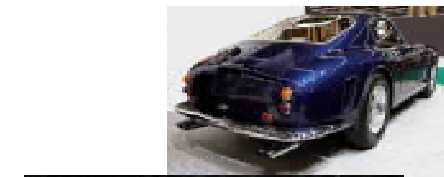

250 GT SWB STRADALE 59>63 (***)
 250 Spider California SWB 59>63 (***)

*** Vetture realizzate completamente a mano; sono possibili differenze che richiedono un adattamento / Handmade cars; some modification may be required to the exhaust system during fitting.

FERRARI: 250 cabriolet pininfarina

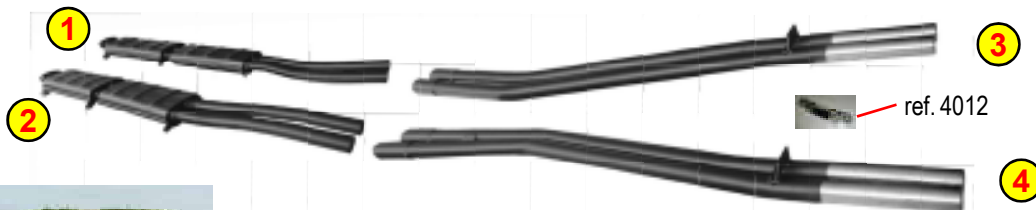

250 GT Cabriolet I Pininfarina 57>58 (***)

- | | | |
|--|-----|--------------|
| 1) Centrale Destro / Centre Silencer R/h | --- | ref. FR 4445 |
| 2) Centrale Sinistro / Centre Silencer L/h | --- | ref. FR 4455 |
| 3) Posteriore Destro / Rear Silencer R/h | --- | ref. FR 4448 |
| 4) Posteriore Sinistro / rear Silencer L/h | --- | ref. FR 4458 |

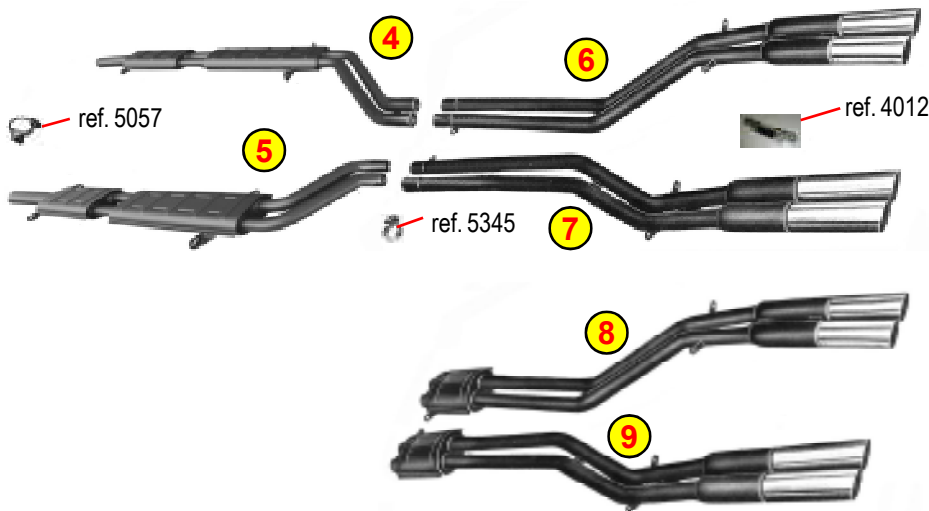
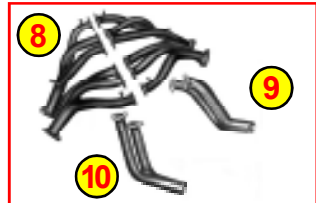
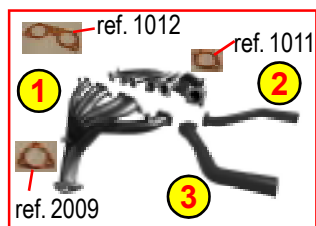

250 GT Cabriolet II Pininfarina 59>62 (***)
LWB - 2600 mm

- con collettori 6-1 / with 6-1 manifolds**
- | | | |
|---|-----|--------------|
| 1) Collettori (Dx+Sx) / Manifolds (R/h+L/h) | --- | ref. FR 0491 |
| 2) Tubi intermedi (Dx+Sx) / Inter pipes (R/h+L/h) | --- | ref. FR 0402 |
| 3) Tubo intermedio Sx / L/h inter pipe | --- | ref. FR 0412 |
| 4) Centrale Dx / Centre Silencer R/h | --- | ref. FR 4225 |
| 5) Centrale Sx / Centre Silencer L/h | --- | ref. FR 4235 |
| 6) Posteriore Destro / Rear Pipes R/h (NO box) | --- | ref. FR 4228 |
| 7) Posteriore Sinistro / Rear Pipes L/h (NO box) | --- | ref. FR 4238 |
| 8) Posteriore Destro / Rear Pipes R/h | --- | ref. FR 4227 |
| 9) Posteriore Sinistro / Rear Pipes L/h | --- | ref. FR 4237 |

- con 2 collettori 3-1 / with double manifolds 3-1**
- | | | |
|---|-----|--------------|
| 8) Collettori (Dx+Sx) / Manifolds (R/h+L/h) | --- | ref. FR 0481 |
| 9) Tubo intermedio Dx / Inter Pipe R/h | --- | ref. FR 4224 |
| 10) Tubo intermedio Sx / Inter Pipe L/h | --- | ref. FR 4234 |

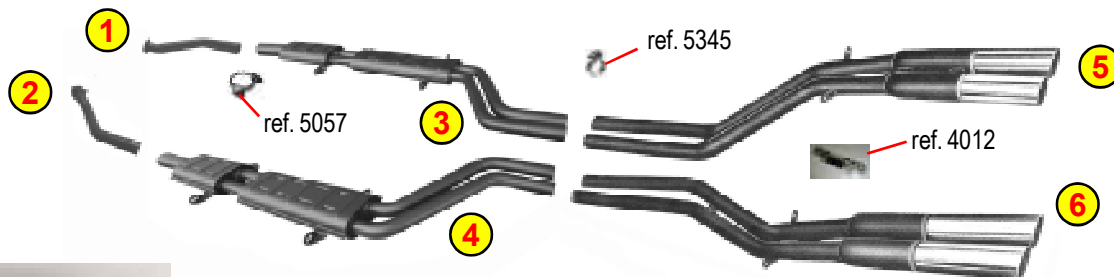

250 GT Cabriolet II Pininfarina 61 (***)
SWB - 2400 mm

- | | | |
|--|-----|--------------|
| 1) Tubo intermedio Dx / Inter Pipe R/h | --- | ref. FR 0402 |
| 2) Tubo intermedio Sx / Inter Pipe L/h | --- | ref. FR 0412 |
| 3) Centrale Destro / Centre Silencer R/h | --- | ref. FR 2925 |
| 4) Centrale Sinistro / Centre Silencer L/h | --- | ref. FR 2935 |
| 5) Posteriore Destro / Rear Silencer R/h | --- | ref. FR 2927 |
| 6) Posteriore Sinistro / rear Silencer L/h | --- | ref. FR 2937 |

*** Vetture realizzate completamente a mano; sono possibili differenze che richiedono un adattamento / Handmade cars; some modification may be required to the exhaust system during fitting.

FERRARI: 250 gte - gtl - gto

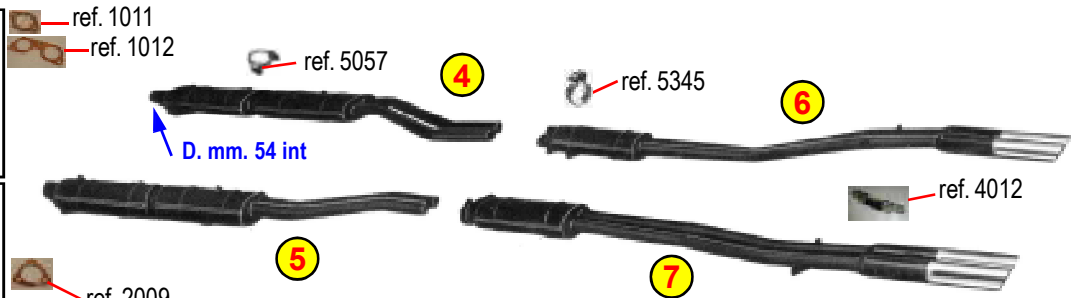
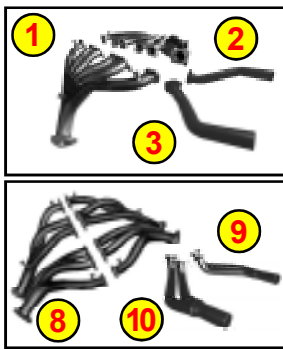

250 GT 2+2 (GTE) 60>63 (***)

con collettori 6-1 / with 6-1 manifolds

- | | | |
|---|-----|--------------|
| 1) Collettori (Dx+Sx) / Manifolds (R/h+L/h) | --- | ref. FR 0491 |
| 2) Tubo intermedio Dx / Inter Pipe R/h | --- | ref. FR 0402 |
| 3) Tubo intermedio Sx / Inter Pipe L/h | --- | ref. FR 0412 |
| 4) Centrale Destro / Centre Silencer R/h | --- | ref. FR 0425 |
| 5) Centrale Sinistro / Centre Silencer L/h | --- | ref. FR 0435 |
| 6) Posteriore Destro / Rear Silencer R/h | --- | ref. FR 0427 |
| 7) Posteriore Sinistro / rear Silencer L/h | --- | ref. FR 0437 |

con 2 collettori 3-1 / with double manifolds 3-1

- | | | |
|---|-----|--------------|
| 8) Collettori (Dx+Sx) / Manifolds (R/h+L/h) | --- | ref. FR 0481 |
| 9) Tubo intermedio Dx / Inter Pipe R/h | --- | ref. FR 0422 |
| 10) Tubo intermedio Sx / Inter Pipe L/h | --- | ref. FR 0432 |

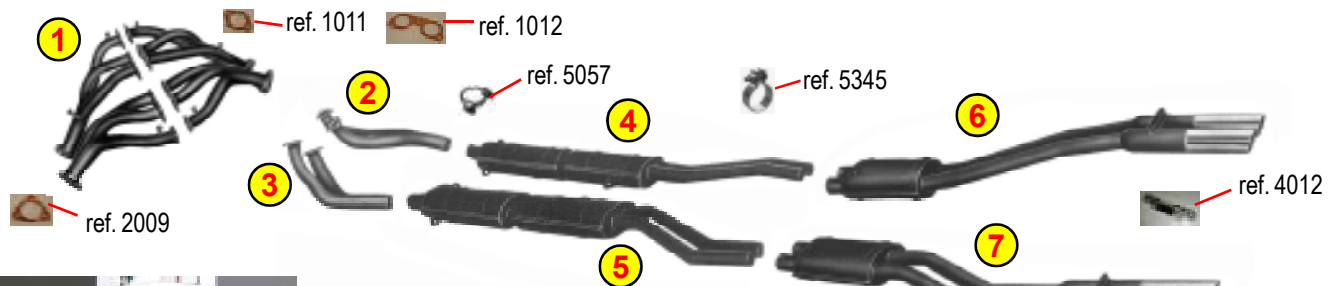

250 GTL (Gran Turismo Lusso) 62>64 (***)

- | | | |
|---|-----|--------------|
| 1) Collettori (Dx+Sx) / Manifolds (R/h+L/h) | --- | ref. FR 0481 |
| 2) Tubo intermedio Dx / Inter Pipe R/h | --- | ref. FR 2522 |
| 3) Tubo intermedio Sx / Inter Pipe L/h | --- | ref. FR 2532 |
| 4) Centrale Destro / Centre Silencer R/h | --- | ref. FR 2525 |
| 5) Centrale Sinistro / Centre Silencer L/h | --- | ref. FR 2535 |
| 6) Posteriore Destro / Rear Silencer R/h | --- | ref. FR 2527 |
| 7) Posteriore Sinistro / rear Silencer L/h | --- | ref. FR 2537 |

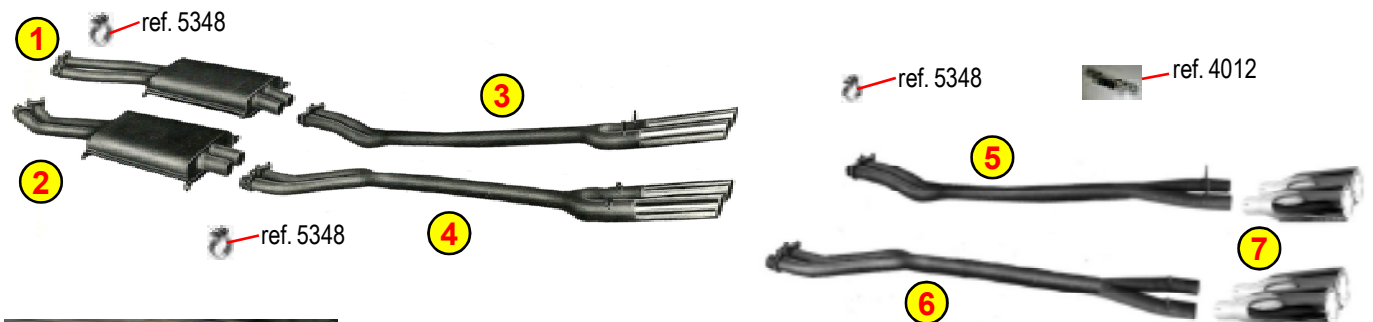

250 GTO 62>66 (***)

- | | | |
|---|-----|--------------|
| 1) Centrale Dx / Centre Silencer R/h | --- | ref. FR 0185 |
| 2) Centrale Sx / Centre Silencer L/h | --- | ref. FR 0195 |
| 3) Posteriore Destro / Rear Pipes R/h (ANSA LOOK) | --- | ref. FR 0128 |
| 4) Posteriore Sinistro / Rear Pipes L/h (ANSA LOOK) | --- | ref. FR 0138 |
| 5) Posteriore Destro / Rear Pipes R/h (ORIGINAL LOOK) | --- | ref. FR 0187 |
| 6) Posteriore Sinistro / Rear Pipes L/h (ORIGINAL LOOK) | --- | ref. FR 0197 |
| 7) Terminale "Snap" / "Snap" Tail Trim (need 4 pcs) | --- | ref. UN 0199 |

*** Vetture realizzate completamente a mano; sono possibili differenze che richiedono un adattamento / Handmade cars; some modification may be required to the exhaust system during fitting.

FERRARI: 275 gtb - gts - gtb/4 - gts/4

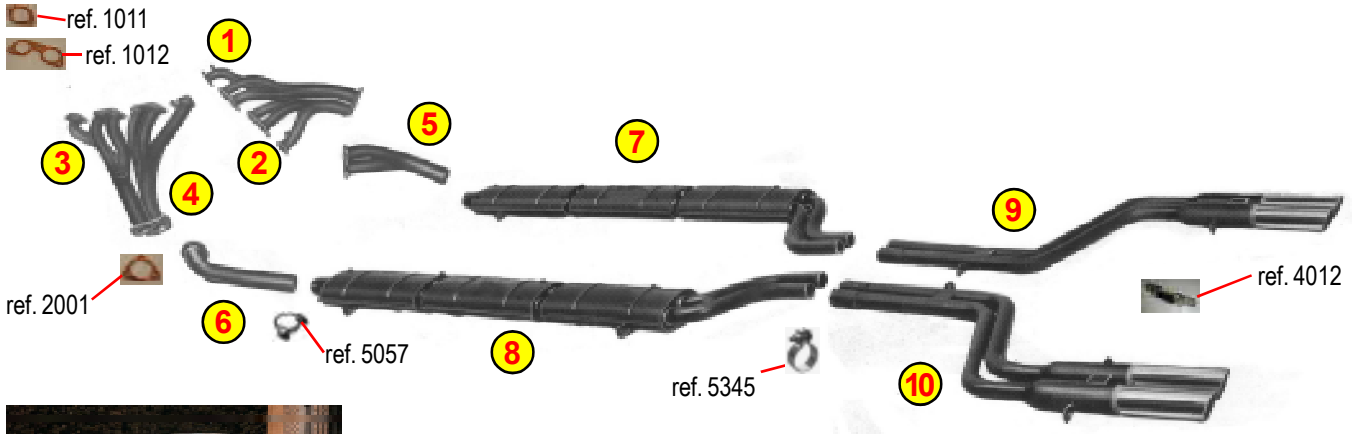

275 GTB - GTS 64>66

- | | | |
|---|-------------------|--------------|
| 1) Collettore anteriore Dx / Front Manifold R/h | 20293 | ref. FR 0501 |
| 2) Collettore posteriore Dx / Rear Manifold R/h | 20295 | ref. FR 0502 |
| 3) Collettore anteriore Sx / Front Manifold L/h | 20292 | ref. FR 0511 |
| 4) Collettore posteriore Sx / Rear Manifold L/h | 20294 | ref. FR 0512 |
| 5) Tubo intermedio Dx / Inter Pipe R/h | 20296 | ref. FR 0504 |
| 6) Tubo intermedio Sx / Inter Pipe L/h | 20297 | ref. FR 0514 |
| 7) Centrale Destro / Centre Silencer R/h | (20286/D-20291/D) | ref. FR 0525 |
| 8) Centrale Sinistro / Centre Silencer L/h | (20286/S-20291/S) | ref. FR 0535 |
| 9) Posteriore Destro / Rear Silencer R/h | (20286/D-20291/D) | ref. FR 0527 |
| 10) Posteriore Sinistro / rear Silencer L/h | (20286/S-20291/S) | ref. FR 0537 |

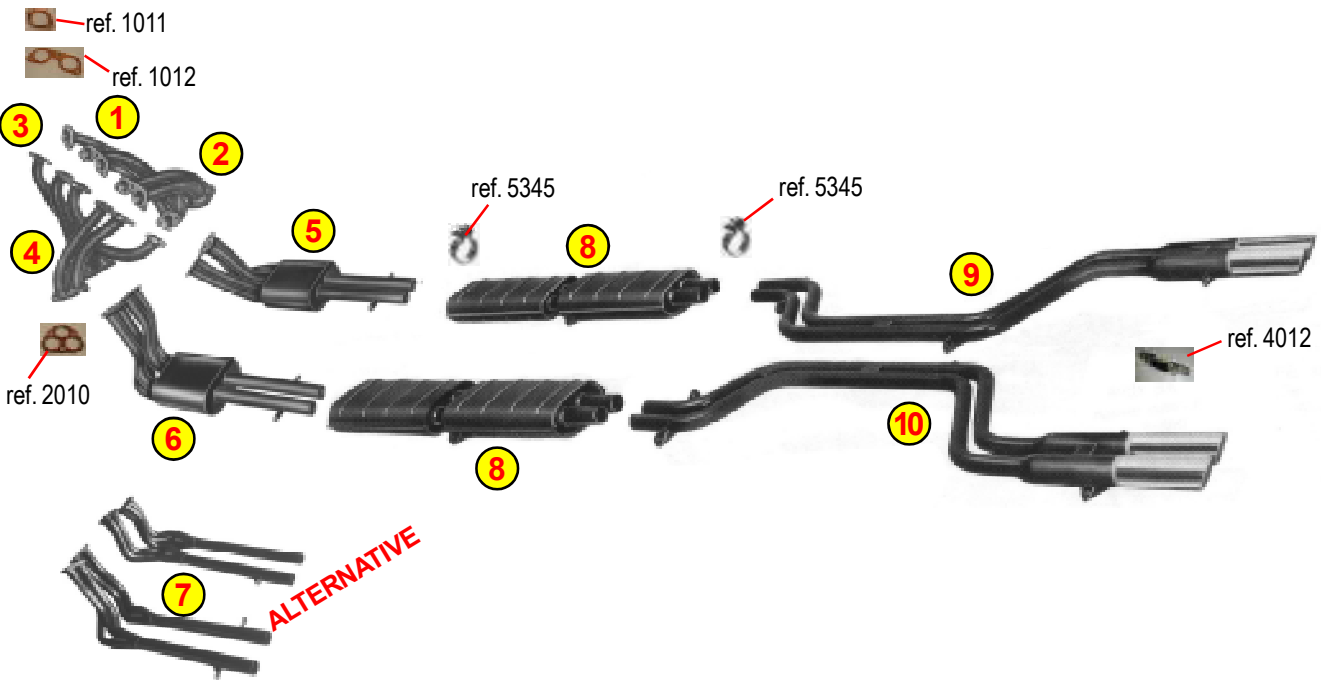

275 GTB/4 - GTS/4 (nart) 66>68

- | | | |
|---|---------|--------------|
| 1) Collettore anteriore Dx / Front Manifold R/h | 20357 | ref. FR 0601 |
| 2) Collettore posteriore Dx / Rear Manifold R/h | 20358 | ref. FR 0602 |
| 3) Collettore anteriore Sx / Front Manifold L/h | 20359 | ref. FR 0611 |
| 4) Collettore posteriore Sx / Rear Manifold L/h | 20360 | ref. FR 0612 |
| 5) Anteriore Destro / Front Silencer R/h | (20343) | ref. FR 0623 |
| 6) Anteriore Sinistro / Front Silencer L/h | (20343) | ref. FR 0633 |
| 7) Tubi Anteriori Dx+Sx) / Front Pipes R/h+L/h | --- | ref. FR 0684 |
| 8) Centrale(servono 2 pz) / Centre Silencer(2 pcs required) | 30350 | ref. FR 0625 |
| 9) Posteriore Destro / Rear Silencer R/h | (20354) | ref. FR 0627 |
| 10) Posteriore Sinistro / rear Silencer L/h | (20354) | ref. FR 0637 |



*** Vetture realizzate completamente a mano; sono possibili differenze che richiedono un adattamento / Handmade cars; some modification may be required to the exhaust system during fitting.

FERRARI: 330 gt 2+2 - 330 gtc/gts - 365 gtc/gts - 365 gt 2+2 (altair)

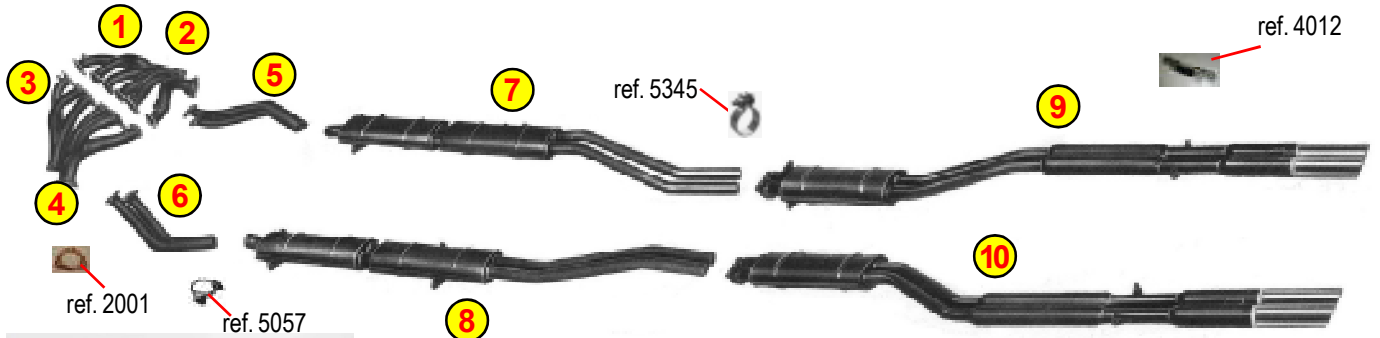
ref. 1013 ref. 1014 ref. 4012



ref. 5345 ref. 2001 ref. 5057



330 GT 2+2 (mk1 & mk2) 64>66
365 California 66>67

1) Collettore anteriore Dx / Front Manifold R/h	(20280)	ref. FR 0701
2) Collettore posteriore Dx / Rear Manifold R/h	(20280)	ref. FR 0702
3) Collettore anteriore Sx / Front Manifold L/h	(20280)	ref. FR 0711
4) Collettore posteriore Sx / Rear Manifold L/h	(20280)	ref. FR 0712
5) Tubo intermedio Dx / Inter Pipe R/h	(20280)	ref. FR 0704
6) Tubo intermedio Sx / Inter Pipe L/h	(20280)	ref. FR 0714
7) Centrale Destro / Centre Silencer R/h	(20280)	ref. FR 0725
8) Centrale Sinistro / Centre Silencer L/h	(20280)	ref. FR 0735
9) Posteriore Destro / Rear Silencer R/h	(20280)	ref. FR 0727
10) Posteriore Sinistro / rear Silencer L/h	(20280)	ref. FR 0737

ref. 1013 ref. 1014 ref. 2001 ref. 4012

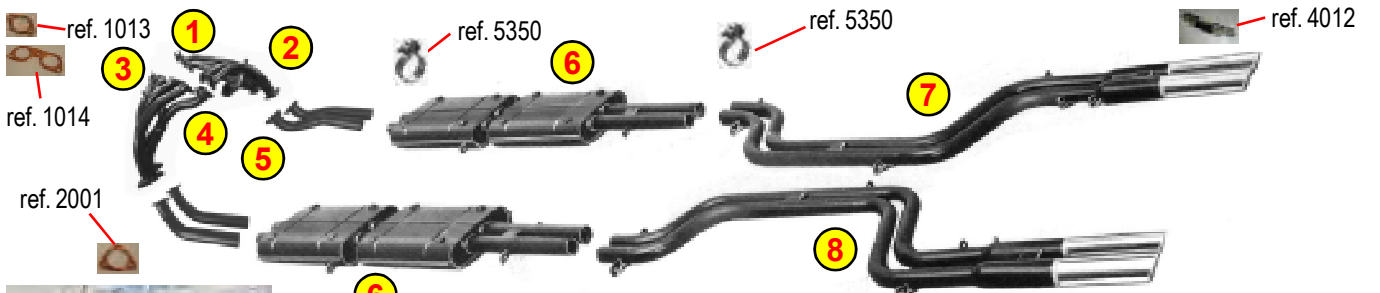

ref. 5350 ref. 5350

330 GTC - GTS 65>67
365 GTC - GTS 68>70

1) Collettore anteriore Dx+Sx / Front Manifolds R/h	(20345/d)	ref. FR 0801
2) Collettore posteriore Dx / Rear Manifold R/h	(20346/d)	ref. FR 0802
3) Collettore anteriore Sx / Front Manifold L/h	(20345/s)	ref. FR 0811
4) Collettore posteriore Sx / Rear Manifold L/h	(20346/s)	ref. FR 0812
5) Gruppo 4 tubi intermedi / Kit 4 Inter Pipes	(20347)	ref. FR 0882
6) Centrale(servono 2 pz)/Centre Silencer(2 pcs required)	(20361)	ref. FR 0825
7) Posteriore Destro / Rear Silencer R/h	(20348/d)	ref. FR 0827
8) Posteriore Sinistro / Rear Silencer L/h	(20348/s)	ref. FR 0837

ref. 1013 ref. 1014 ref. 4012

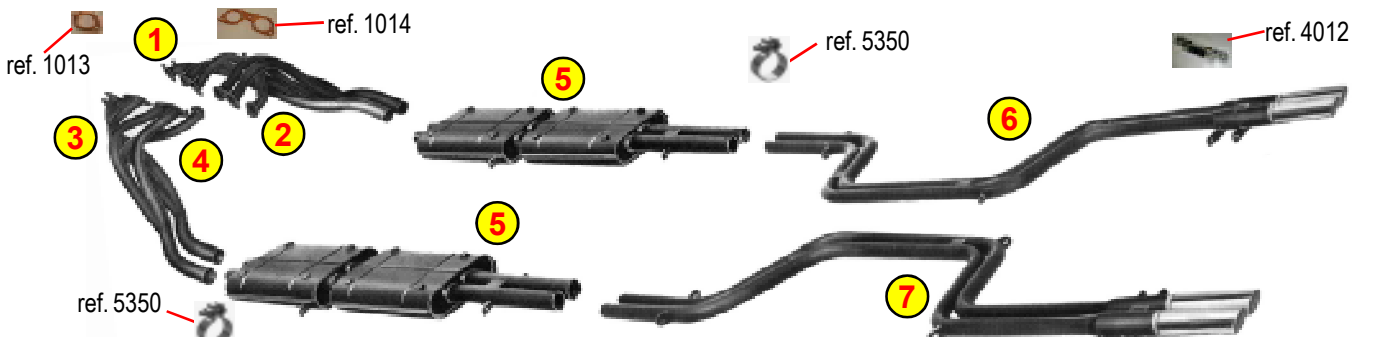

ref. 5350



365 GT 2+2 (Altair) 68>70

1) Collettore anteriore Dx+Sx / Front Manifolds R/h	(20345/d)	ref. FR 0901
2) Collettore posteriore Dx / Rear Manifold R/h	(20346/d)	ref. FR 0902
3) Collettore anteriore Sx / Front Manifold L/h	(20345/s)	ref. FR 0911
4) Collettore posteriore Sx / Rear Manifold L/h	(20346/s)	ref. FR 0912
5) Centrale(servono 2 pz)/Centre Silencer(2 pcs required)	(20361)	ref. FR 0825
6) Posteriore Destro / Rear Silencer R/h	(20348/d)	ref. FR 0927
7) Posteriore Sinistro / Rear Silencer L/h	(20348/s)	ref. FR 0937

FERRARI: 365 gtb/4 (Daytona)

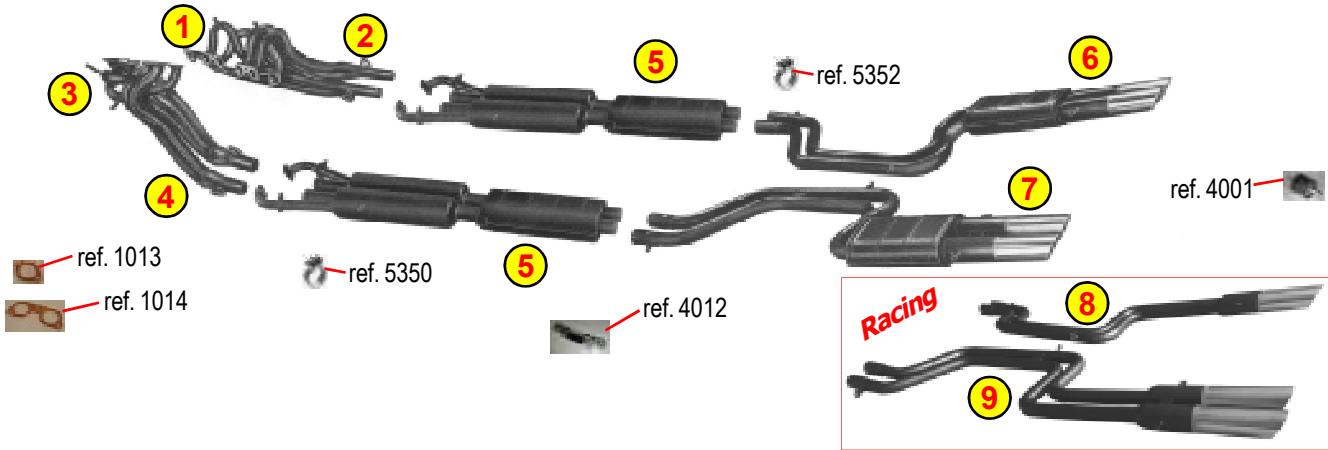

365 GTB/4 (Daytona) 1° serie
(>ch 15063) 68>70

- | | | |
|---|---------|--------------|
| 1) Collettore Ant.Dx / Front Manifolds R/h | 20435 | ref. FR 1001 |
| 2) Collettore Post.Dx / Rear Manifolds R/h | 20437 | ref. FR 1002 |
| 3) Collettore Ant.Sx / Front Manifolds L/h | 20436 | ref. FR 1011 |
| 4) Collettore Post.Sx / Rear Manifolds L/h | 20438 | ref. FR 1012 |
| 5) Centrale(servono 2 pz)/Centre Silencer(2 pcs required) | 20361 | ref. FR 1025 |
| 6) Posteriore Destro / Rear Silencer R/h | 20445 | ref. FR 1027 |
| 7) Posteriore Sinistro / Rear Silencer L/h | 20446 | ref. FR 1037 |
| 8) Posteriore Destro / Rear Pipes R/h (Racing) | (20445) | ref. FR1028 |
| 9) Posteriore Sinistro / Rear Pipes L/h (Racing) | (20446) | ref. FR1038 |

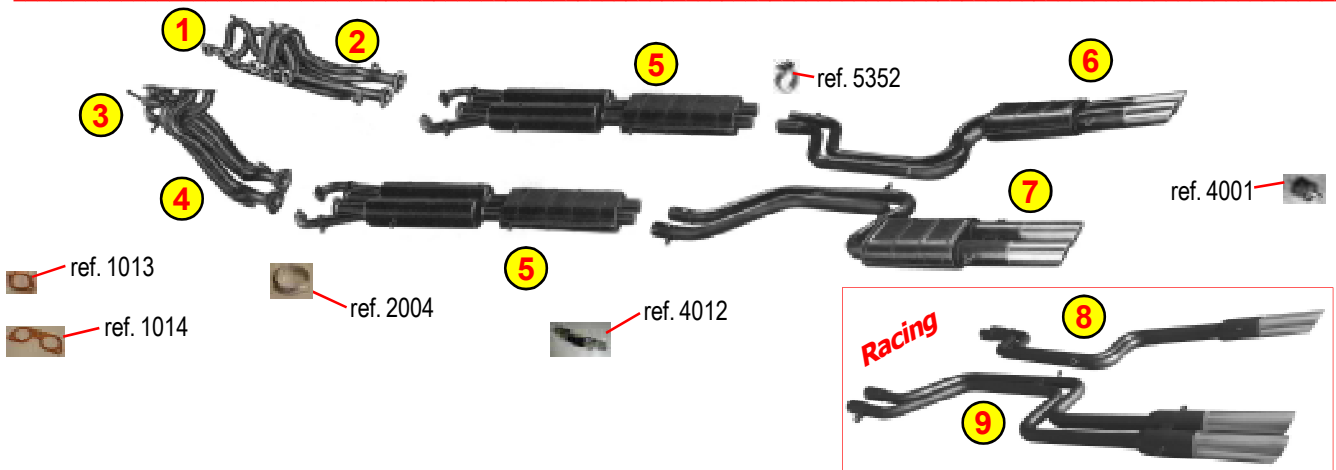

365 GTB/4 (Daytona) 2° serie
(ch 15065>) 70>73

- | | | |
|---|---------|--------------|
| 1) Collettore Ant.Dx / Front Manifolds R/h | 20510/d | ref. FR 1101 |
| 2) Collettore Post.Dx / Rear Manifolds R/h | 20511/d | ref. FR 1102 |
| 3) Collettore Ant.Sx / Front Manifolds L/h | 20510/s | ref. FR 1111 |
| 4) Collettore Post.Sx / Rear Manifolds L/h | 20511/s | ref. FR 1112 |
| 5) Centrale(servono 2 pz)/Centre Silencer(2 pcs required) | 20512 | ref. FR 1125 |
| 6) Posteriore Destro / Rear Silencer R/h | 20445 | ref. FR 1027 |
| 7) Posteriore Sinistro / Rear Silencer L/h | 20446 | ref. FR 1037 |
| 8) Posteriore Destro / Rear Pipes R/h (Racing) | (20445) | ref. FR1028 |
| 9) Posteriore Sinistro / Rear Pipes L/h (Racing) | (20446) | ref. FR1038 |

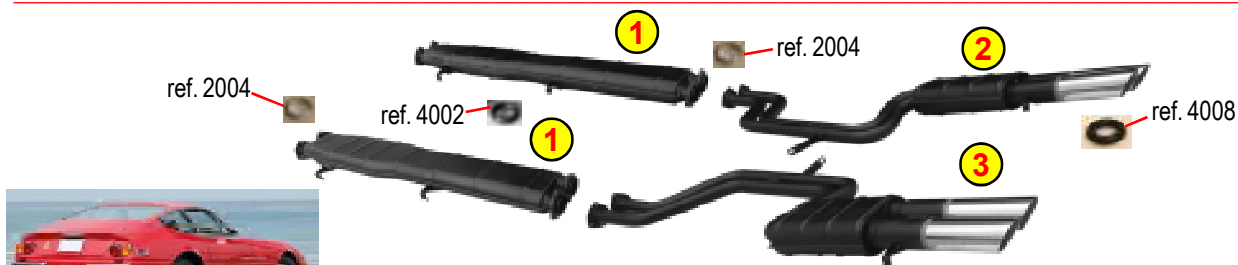

365 GTB/4 (Daytona) 70>73



- | | | |
|---|--------|--------------|
| 1) Centrale(servono 2 pz)/Centre Silencer(2 pcs required) | 350134 | ref. FR 1145 |
| 2) Posteriore Destro / Rear Silencer R/h | 350135 | ref. FR 1147 |
| 3) Posteriore Sinistro / Rear Silencer L/h | 350136 | ref. FR 1157 |

FERRARI: 365 gtc/4 - gt/4 2+2 - 400 s.america

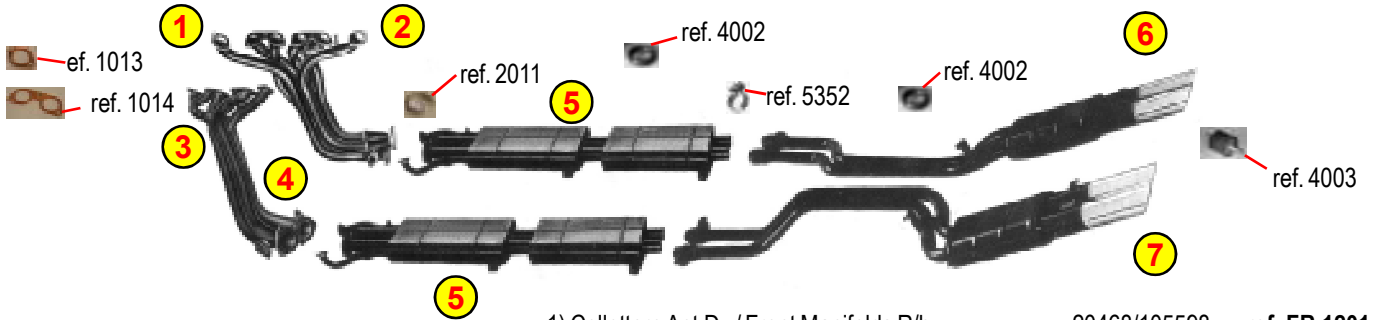

365 GTC/4 Coupé (Gobbone) 71>72

- | | | |
|---|--------------|--------------|
| 1) Collettore Ant.Dx / Front Manifolds R/h | 20468/105598 | ref. FR 1201 |
| 2) Collettore Post.Dx / Rear Manifolds R/h | 20470/105601 | ref. FR 1202 |
| 3) Collettore Ant.Sx / Front Manifolds L/h | 20469/105599 | ref. FR 1211 |
| 4) Collettore Post.Sx / Rear Manifolds L/h | 20471/105600 | ref. FR 1212 |
| 5) Centrale(servono 2 pz)/Centre Silencer(2 pcs required) | 20483/105603 | ref. FR 1325 |
| 6) Posteriore Destro / Rear Silencer R/h | 20484/102216 | ref. FR 1227 |
| 7) Posteriore Sinistro / Rear Silencer L/h | 20485/102217 | ref. FR 1237 |



365 GTC/4 Coupé 71>72

USA model

- | | | |
|---|-----|--------------|
| 1) Centrale(servono 2 pz)/Centre Silencer(2 pcs required) | --- | ref. FR 1245 |
| 2) Posteriore Destro / Rear Silencer R/h | --- | ref. FR 1247 |
| 3) Posteriore Sinistro / Rear Silencer L/h | --- | ref. FR 1257 |

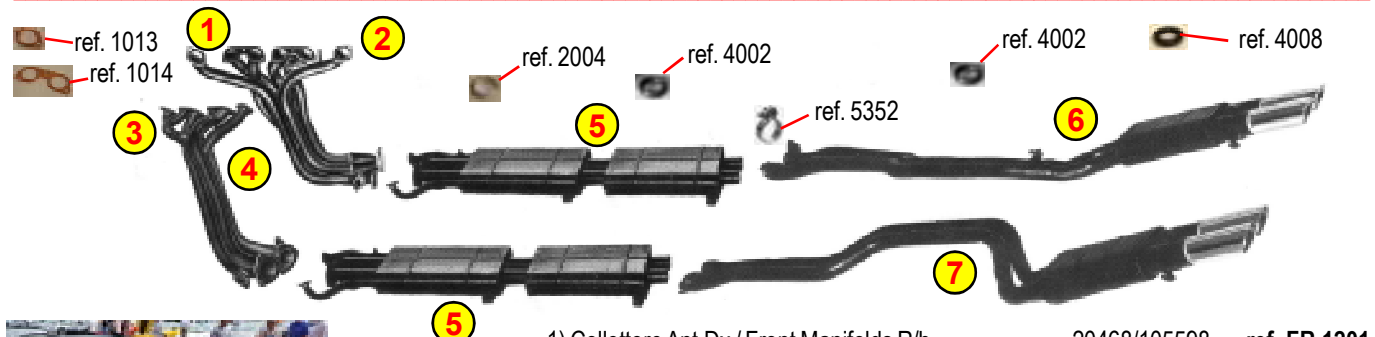

365 GT/4 2+2 (72>76)

- | | | |
|---|--------------|--------------|
| 1) Collettore Ant.Dx / Front Manifolds R/h | 20468/105598 | ref. FR 1201 |
| 2) Collettore Post.Dx / Rear Manifolds R/h | 20470/105601 | ref. FR 1202 |
| 3) Collettore Ant.Sx / Front Manifolds L/h | 20469/105599 | ref. FR 1211 |
| 4) Collettore Post.Sx / Rear Manifolds L/h | 20471/105600 | ref. FR 1212 |
| 5) Centrale(servono 2 pz)/Centre Silencer(2 pcs required) | 20483/105603 | ref. FR 1325 |
| 6) Posteriore Destro / Rear Silencer R/h | 104981 | ref. FR 1327 |
| 7) Posteriore Sinistro / Rear Silencer L/h | 104982 | ref. FR 1337 |

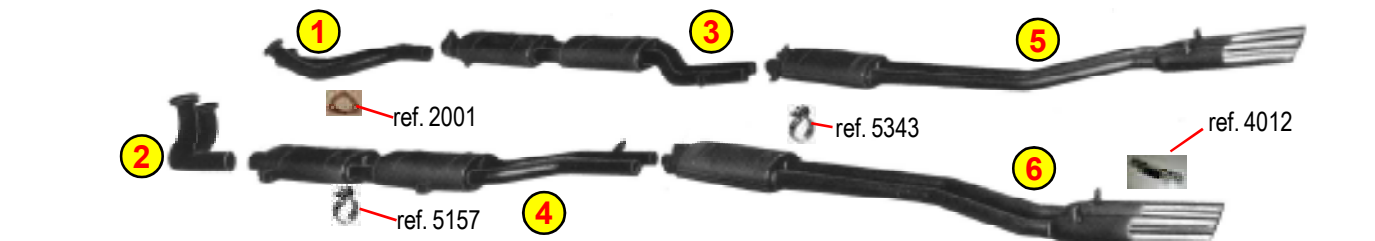

400 Superamerica 61>64 (***)

- | | | |
|--|-----|--------------|
| 1) Tubo intermedio Dx / Inter Pipe R/h | --- | ref. FR 0322 |
| 2) Tubo intermedio Sx / Inter Pipe L/h | --- | ref. FR 0332 |
| 3) Centrale Destro / Centre Silencer R/h | --- | ref. FR 0325 |
| 4) Centrale Sinistro / Centre Silencer L/h | --- | ref. FR 0335 |
| 5) Posteriore Destro / Rear Silencer R/h | --- | ref. FR 0327 |
| 6) Posteriore Sinistro / Rear Silencer L/h | --- | ref. FR 0337 |

*** Vetture realizzate completamente a mano; sono possibili differenze che richiedono un adattamento / Handmade cars; some modification may be required to the exhaust system during fitting.

FERRARI: 400 - 410 - 412

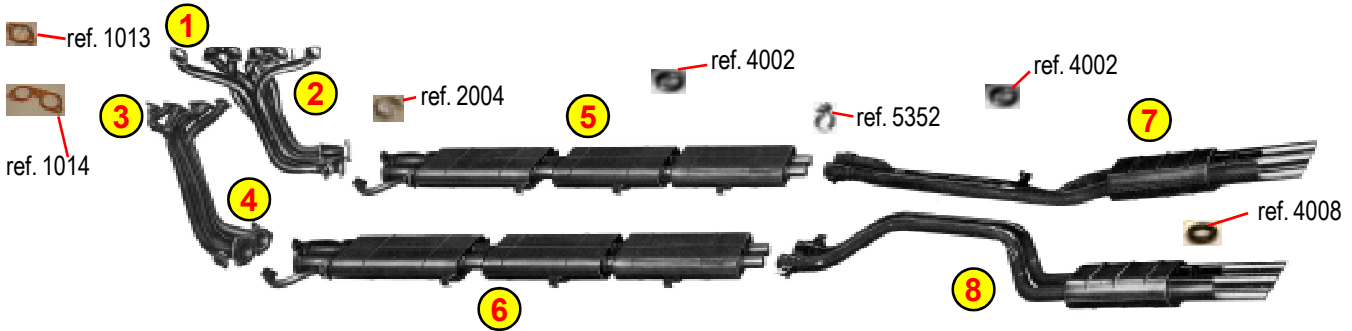

400 GT - 400 Automatic - 400i 76>85

- | | | |
|--|---------------|--------------|
| 1) Collettore Ant.Dx / Front Manifolds R/h | 105598/118724 | ref. FR 1201 |
| 2) Collettore Post.Dx / Rear Manifolds R/h | 105601/118726 | ref. FR 1202 |
| 3) Collettore Ant.Sx / Front Manifolds L/h | 105599/118725 | ref. FR 1211 |
| 4) Collettore Post.Sx / Rear Manifolds L/h | 105600/118727 | ref. FR 1212 |
| 5) Centrale Destro / Centre Silencer R/h | 110894 | ref. FR 1425 |
| 6) Centrale Sinistro / Centre Silencer L/h | 110895 | ref. FR 1435 |
| 7) Posteriore Destro / Rear Silencer R/h | 110896 | ref. FR 2427 |
| 8) Posteriore Sinistro / Rear Silencer L/h | 110897 | ref. FR 2437 |



410 SA - 410 Superfast (passo 2800) 56>59



- | | | |
|--|-----|--------------|
| 1) Centrale Destro / Centre Silencer R/h | --- | ref. FR 6225 |
| 2) Centrale Sinistro / Centre Silencer L/h | --- | ref. FR 6235 |
| 3) Posteriore Destro / Rear Silencer R/h | --- | ref. FR 6227 |
| 4) Posteriore Sinistro / Rear Silencer L/h | --- | ref. FR 6237 |



412 85>89



- | | | |
|---|--------|--------------|
| 1) Centrale(servono 2 pz)/Centre Silencer(2 pcs required) | 126742 | ref. FR 4105 |
| 2) Posteriore Destro / Rear Silencer R/h | 126743 | ref. FR 2427 |
| 3) Posteriore Sinistro / Rear Silencer L/h | 126747 | ref. FR 2437 |



412 (400) SVIZZERA 76>89



- | | | |
|--|--------|--------------|
| 1) Silez. Trasversale / transversal silencer | 134697 | ref. FR 2445 |
| 2) Posteriore Destro / Rear Silencer R/h | 134719 | ref. FR 2447 |
| 3) Posteriore Sinistro / Rear Silencer L/h | 134720 | ref. FR 2457 |

FERRARI: 456 - 500 Superfast - 550



456 GT - GTA - M GT - M GTA 92>03

1) Catalizzatore Dx / R/h C.Converter	178414	ref. FR 5203
2) Catalizzatore Sx / L/h C.Converter	178415	ref. FR 5213
3) Tronchetti Sost. Cat (Dx+Sx) / Test Pipes (R/h+L/h)	---	ref. FR 5224
4) Posteriore Destro / Rear Silencer R/h	156347	ref. FR 5227
5) Posteriore Sinistro / Rear Silencer L/h	156348	ref. FR 5237

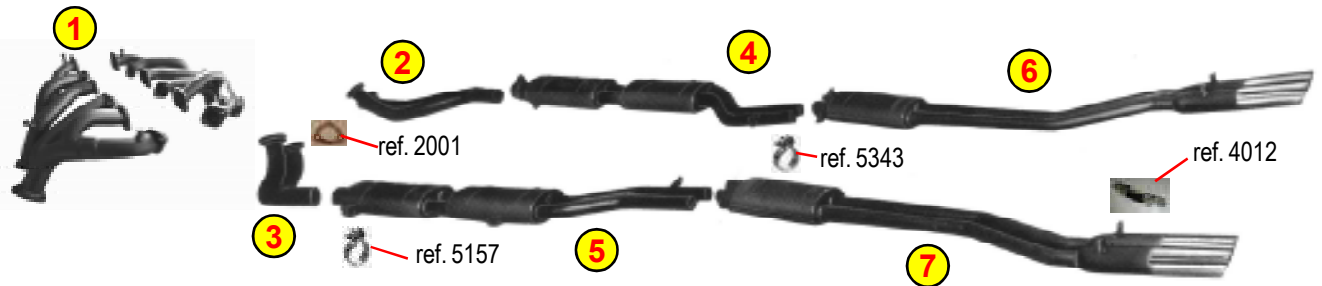

500 Superfast 64>66 (***)

1) Collettori (dx+sx) / Manifolds (R/h+L/h)	---	ref. FR 0381
2) Tubo intermedio Dx / Inter Pipe R/h	---	ref. FR 0342
3) Tubo intermedio Sx / Inter Pipe L/h	---	ref. FR 0352
3) Centrale Destro / Centre Silencer R/h	---	ref. FR 0325
5) Centrale Sinistro / Centre Silencer L/h	---	ref. FR 0335
6) Posteriore Destro / Rear Silencer R/h	---	ref. FR 0327
7) Posteriore Sinistro / Rear Silencer L/h	---	ref. FR 0337

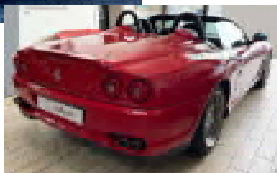
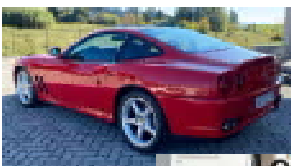
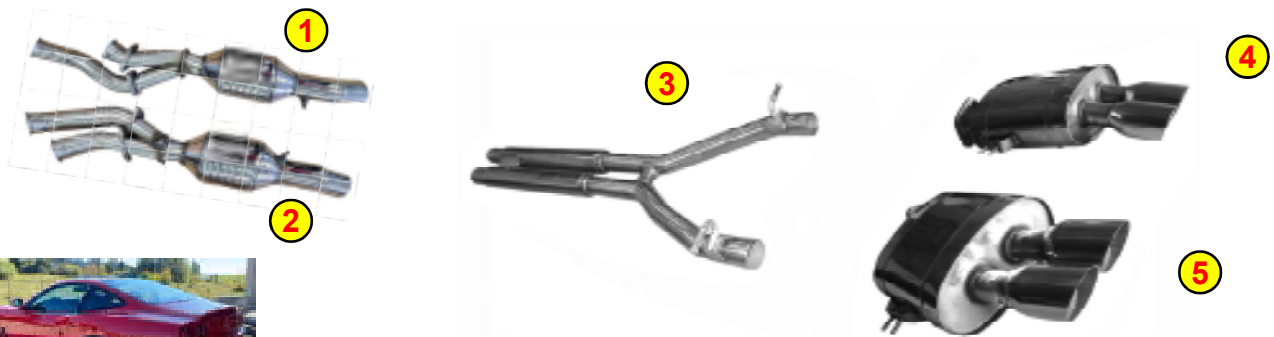

550 Maranello -Barchetta 96>01

1) Catalizzatore Dx / R/h C.Converter	167993	ref. FR 5303
2) Catalizzatore Sx / L/h C.Converter	167994	ref. FR 5313
3) Centrale / Centre Silencer	167995	ref. FR 5325
4) Posteriore Destro / Rear Silencer R/h	167998	ref. FR 5327
5) Posteriore Sinistro / Rear Silencer L/h	167999	ref. FR 5337

*** Vetture realizzate completamente a mano; sono possibili differenze che richiedono un adattamento / Handmade cars; some modification may be required to the exhaust system during fitting.

FERRARI: 575 - F599 - 612



575 M Maranello - M Superamerica 02>06

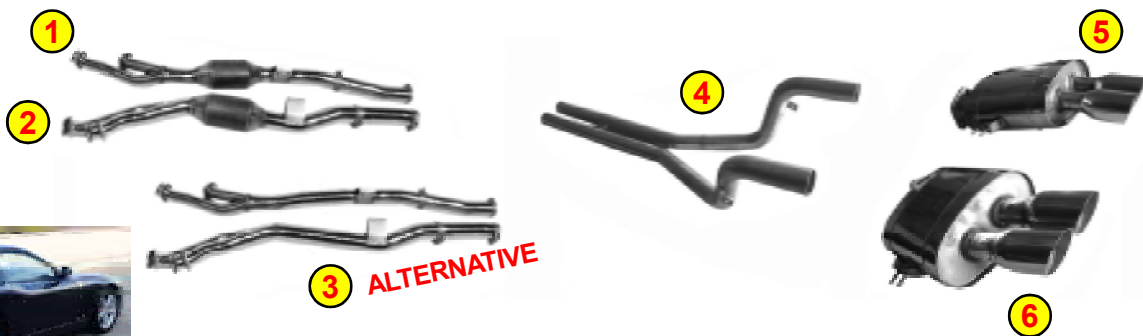

- | | | |
|--|--------|--------------|
| 1) Catalizzatore Dx / R/h C. Converter | 185647 | ref. FR 5343 |
| 2) Catalizzatore Sx / L/h C. Converter | 185648 | ref. FR 5353 |
| 3) Tronchetti Sost. Cat (Dx+Sx) / Test Pipes (R/h+L/h) | --- | ref. FR 5344 |
| 4) Centrale / Centre Silencer | 167995 | ref. FR 5335 |
| 5) Posteriore Destro / Rear Silencer R/h | 167998 | ref. FR 5327 |
| 6) Posteriore Sinistro / Rear Silencer L/h | 167999 | ref. FR 5337 |



F599 Fiorano 07>12



- | | | |
|--|--------|--------------|
| 1) Catalizzatore Dx / R/h C. Converter | 178414 | ref. FR 5503 |
| 2) Catalizzatore Sx / L/h C. Converter | 178415 | ref. FR 5513 |
| 3) Tronchetti Sost. Cat (Dx+Sx) / Test Pipes (R/h+L/h) | --- | ref. FR 5524 |
| 4) Posteriore Destro / Rear Silencer R/h | 156347 | ref. FR 5527 |
| 5) Posteriore Sinistro / Rear Silencer L/h | 156348 | ref. FR 5537 |



612 Scaglietti 04>11



- | | | |
|--|--------|--------------|
| 1) Catalizzatore Dx / R/h C. Converter | 178414 | ref. FR 5403 |
| 2) Catalizzatore Sx / L/h C. Converter | 178415 | ref. FR 5413 |
| 3) Tronchetti Sost. Cat (Dx+Sx) / Test Pipes (R/h+L/h) | --- | ref. FR 5424 |
| 4) Posteriore Destro / Rear Silencer R/h | 156347 | ref. FR 5427 |
| 5) Posteriore Sinistro / Rear Silencer L/h | 156348 | ref. FR 5437 |

FERRARI: 365 bb - 512 bb/bbi

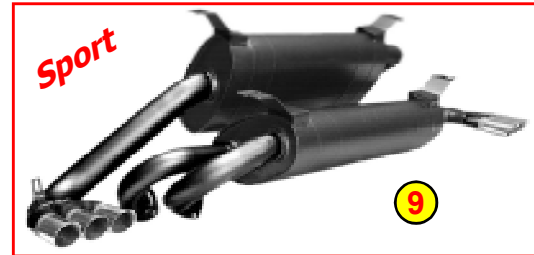
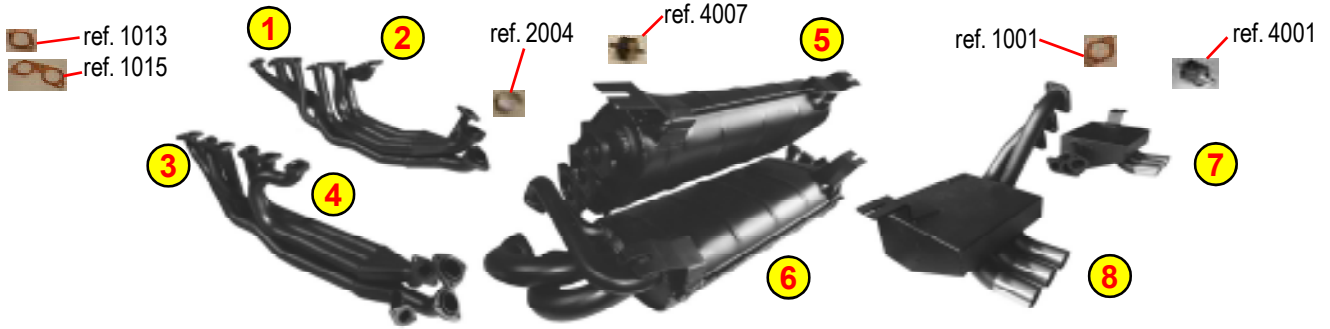

BB 365 GT4 (Berlinetta Boxer) 72>76

- | | | |
|--|--------|--------------|
| 1) Collettore Ant.Dx / Front Manifolds R/h | 105890 | ref. FR 2201 |
| 2) Collettore Post.Dx / Rear Manifolds R/h | 105892 | ref. FR 2202 |
| 3) Collettore Ant.Sx / Front Manifolds L/h | 105889 | ref. FR 2211 |
| 4) Collettore Post.Sx / Rear Manifolds L/h | 105891 | ref. FR 2212 |
| 5) Centrale Superiore / Top Centre Silencer | 105886 | ref. FR 2245 |
| 6) Centrale Inferiore / Bottom Center Silencer | 107250 | ref. FR 2255 |
| 7) Posteriore Destro / R/h Rear Silencer | 105888 | ref. FR 2247 |
| 8) Posteriore Sinistro / L/h Rear Silencer | 105887 | ref. FR 2257 |
| 9) Gruppo Sport /Sport Silencer(3 tail pipes) | --- | ref. FR 2220 |

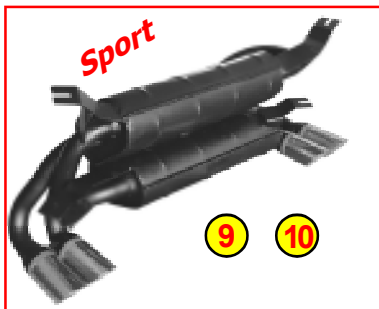
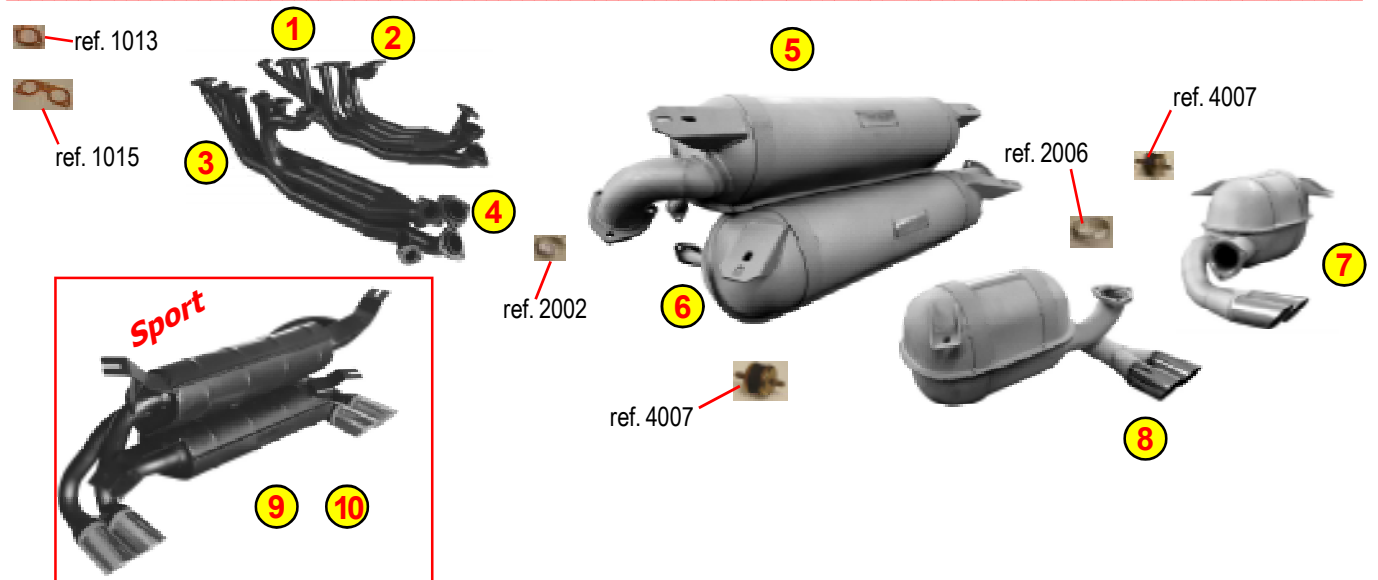

BB 512 - BBi 512i (Berlinetta Boxer) 76>84

- | | | |
|---|--------|--------------|
| 1) Collettore Ant.Dx / Front Manifolds R/h | 110002 | ref. FR 2301 |
| 2) Collettore Post.Dx / Rear Manifolds R/h | 110004 | ref. FR 2302 |
| 3) Collettore Ant.Sx / Front Manifolds L/h | 110001 | ref. FR 2311 |
| 4) Collettore Post.Sx / Rear Manifolds L/h | 110003 | ref. FR 2312 |
| 5) Centrale Superiore / Top Centre Silencer | 109127 | ref. FR 2305 |
| 6) Centrale Inferiore / Bottom Center Silencer | 109126 | ref. FR 2315 |
| 7) Posteriore Destro / R/h Rear Silencer | 110309 | ref. FR 2307 |
| 8) Posteriore Sinistro / L/h Rear Silencer | 110310 | ref. FR 2317 |
| 9) Gruppo Sport /Sport Silencers (R/h+L/h) | --- | ref. FR 2320 |

BB 512 - BBi 512i (Berlinetta Boxer) 76>84
 con collettori maggiorati
 with larger diameter manifolds

- | | | |
|--|-----|--------------|
| 10) Gruppo Sport /Sport Silencers (R/h+L/h) | --- | ref. FR 2330 |
|--|-----|--------------|

FERRARI: testarossa - 512 tr

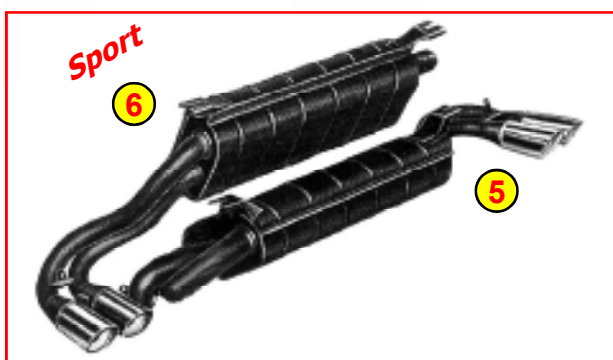
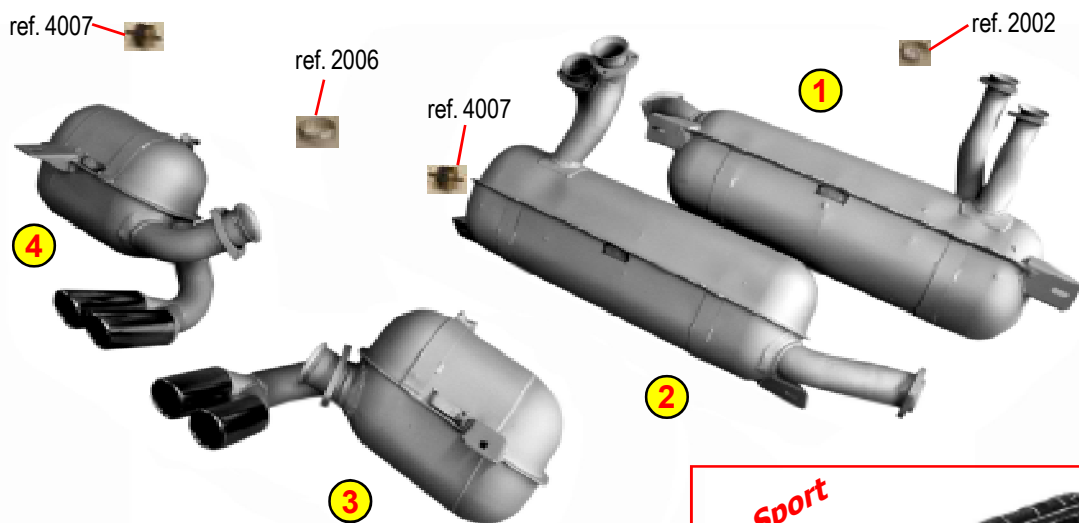

1) Centrale Superiore / Top Centre Silencer	124495	ref. FR 3805
2) Centrale Inferiore / Bottom Center Silencer	124496	ref. FR 3815
3) Posteriore Destro / R/h Rear Silencer	124497	ref. FR 3807
4) Posteriore Sinistro / L/h Rear Silencer	124498	ref. FR 3817
5) Posteriore Destro Sport / R/h Sport Silencer	---	ref. FR 3827
6) Posteriore Sinistro Sport / L/h Sport Silencer	---	ref. FR 3837

TESTAROSSA - Non Catalizzata 84>89

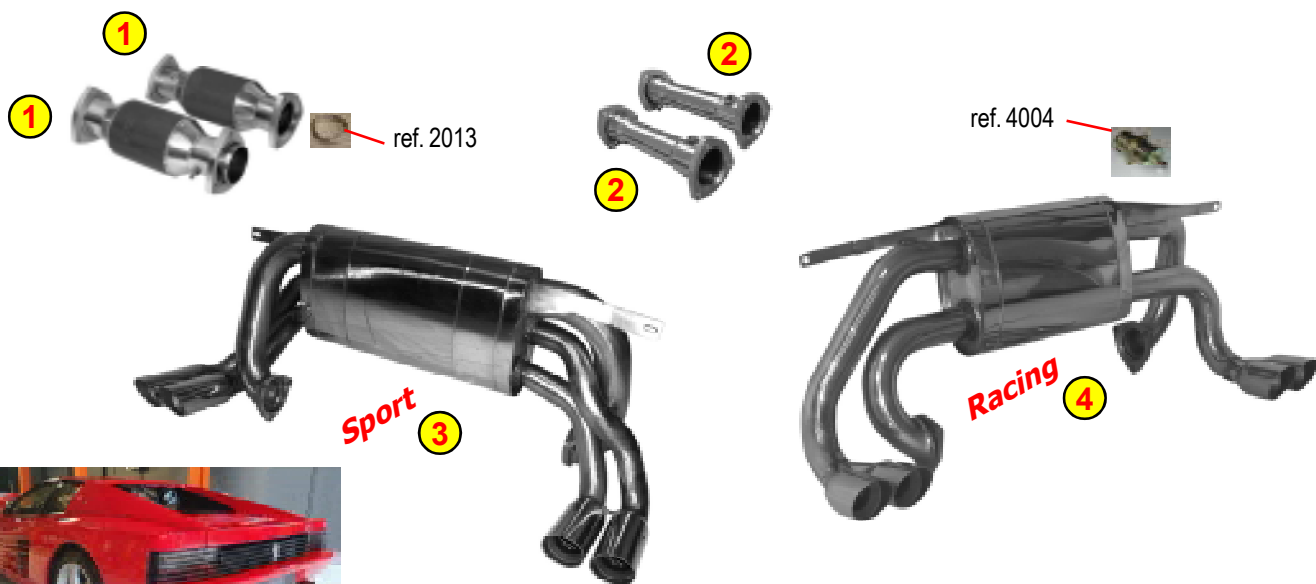

1) Catalizzatore(servono 2 pz)/C.Converer (2 pcs required)	121395-149304	ref. FR 3023
2)Tronchetti (servono 2 pz) / Test Pipes (2 pcs required)	126534	ref. FR 3024
3) Silenziatore Sport / Sport Silencer	(125928-149784)	ref. FR 4520
4) Silenziatore Racing / Racing Sound Silencer	(125928-149784)	ref. FR 4580

TESTAROSSA - Catalizzata 89>92
512 TR - F512M 92>96

FIAT: 500 - 126 - 124 Spider - 124 Abarth - 131 Abarth - X1/9



500 D/F/L 57>72

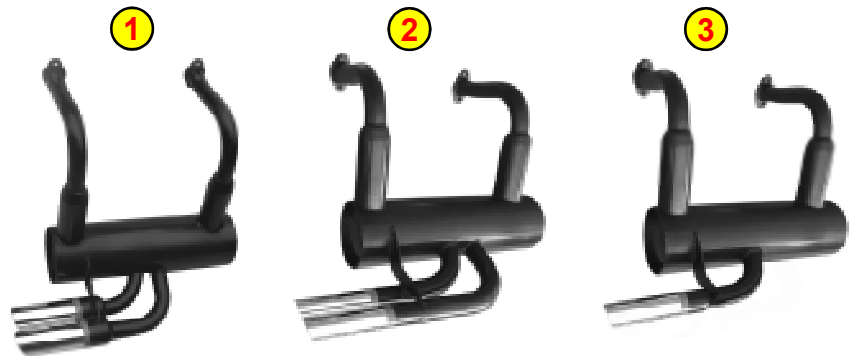

- | | | |
|--|----------------|--------------|
| 1) Silenziatore / Silencer (2 T.Pipe d.55) | 989217-4146056 | ref. FR 0220 |
| 2) Silenziatore / Silencer (2 T.Pipe d.30) | 989217-4146056 | ref. FR 0230 |
| 3) Silenziatore / Silencer (1 T.Pipe d.63) | 989217-4146056 | ref. FR 0280 |



500 R - 126 72>00

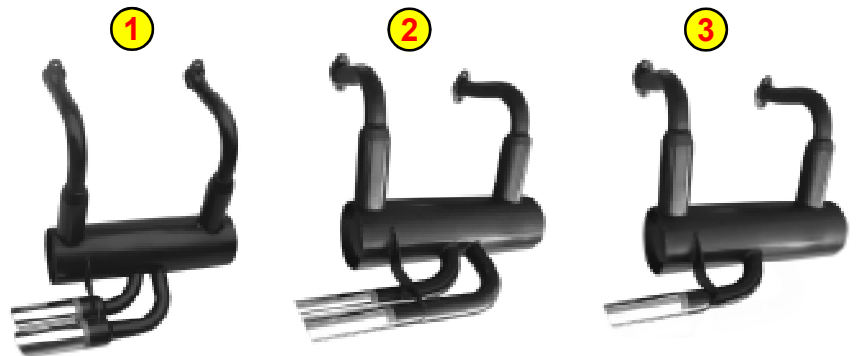

- | | | |
|--|---------|--------------|
| 1) Silenziatore / Silencer (2 T.Pipe d.55) | 4271044 | ref. FR 0320 |
| 2) Silenziatore / Silencer (2 T.Pipe d.30) | 4271044 | ref. FR 0330 |
| 3) Silenziatore / Silencer (1 T.Pipe d.63) | 4271044 | ref. FR 0380 |

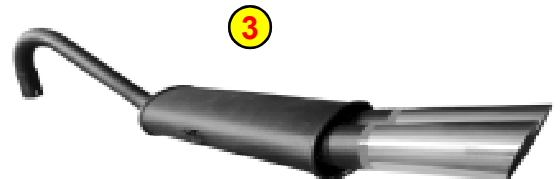
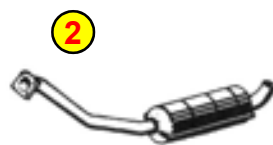
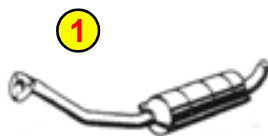

124 Spider 1.4-1.6-1.8-2.0 Spidereuropa (72>82)

- | | | |
|--|-----------------|--------------|
| 1) Centrale / Centre silencer (1.8 Kat) | --- | ref. FT 7045 |
| 2) Centrale / Centre silencer (2.0 Kat) | 4443325 | ref. FT 7245 |
| 3) Silenziatore Posteriore/Rear Silencer | 4299172-5976128 | ref. FT 2567 |

LAMBORGHINI: aventador - 350 gt - 400 gt



AVENTADOR (2011>)

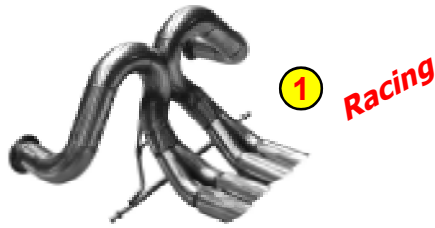

1) Scarico Racing / Racing Exhaust

470251051

ref. LM 4320

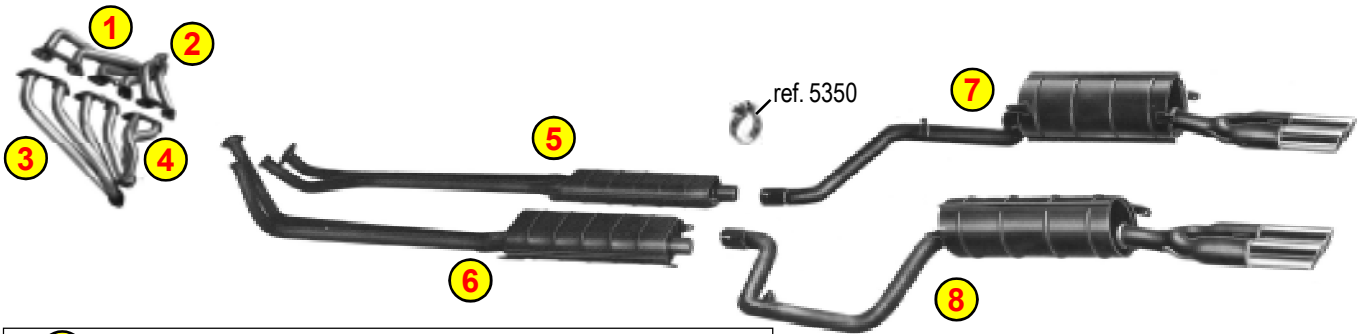

ALTERNATIVA PER VETTURE CON COLLETTORI 400 GT
OPTION FOR CARS WITH 400 GT MANIFOLDS

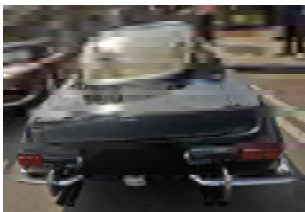

350 GT Touring (64>66)

1) Collettore Ant.Dx / Front Manifolds R/h	001101793	ref. LM 0201
2) Collettore Post.Dx / Rear Manifolds R/h	001101439	ref. LM 0202
3) Collettore Ant.Sx / Front Manifolds L/h	---	ref. LM 0111
4) Collettore Post.Sx / Rear Manifolds L/h	---	ref. LM 0112
5) Centrale Destro / Centre Silencer R/h	004401796	ref. LM 0125
6) Centrale Sinistro / Centre Silencer L/h	004411795	ref. LM 0135
7) Posteriore Destro / Rear Silencer R/h	004401797	ref. LM 0127
8) Posteriore Sinistro / Rear Silencer L/h	004401798	ref. LM 0137
<hr/>		
9) Collettore Ant.Sx / Front Manifolds L/h	001103217	ref. LM 0211
10) Collettore Post.Sx / Rear Manifolds L/h	001103218	ref. LM 0212
11) Centrale Sinistro / Centre Silencer L/h	---	ref. LM 0195

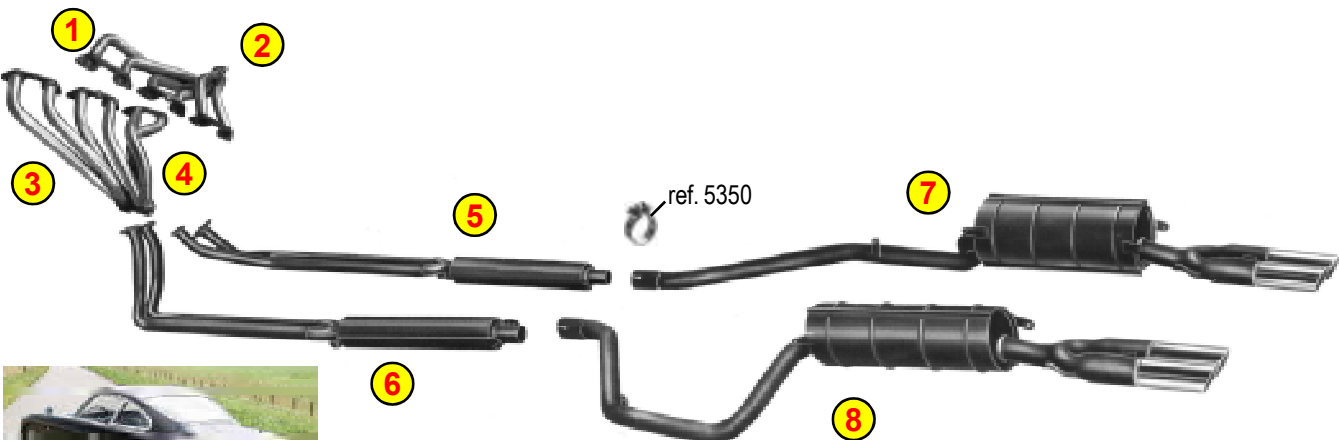

400 GT 2+2 (66>68)

1) Collettore Ant.Dx / Front Manifolds R/h	001101793	ref. LM 0201
2) Collettore Post.Dx / Rear Manifolds R/h	001101439	ref. LM 0202
3) Collettore Ant.Sx / Front Manifolds L/h	001103217	ref. LM 0211
4) Collettore Post.Sx / Rear Manifolds L/h	001103218	ref. LM 0212
5) Centrale Destro / Centre Silencer R/h	004403198	ref. LM 0225
6) Centrale Sinistro / Centre Silencer L/h	004403197	ref. LM 0235
7) Posteriore Destro / Rear Silencer R/h	004403201	ref. LM 0227
8) Posteriore Sinistro / Rear Silencer L/h	004403202	ref. LM 0237

LAMBORGHINI: countach Ip 400 - 400s - 5000s

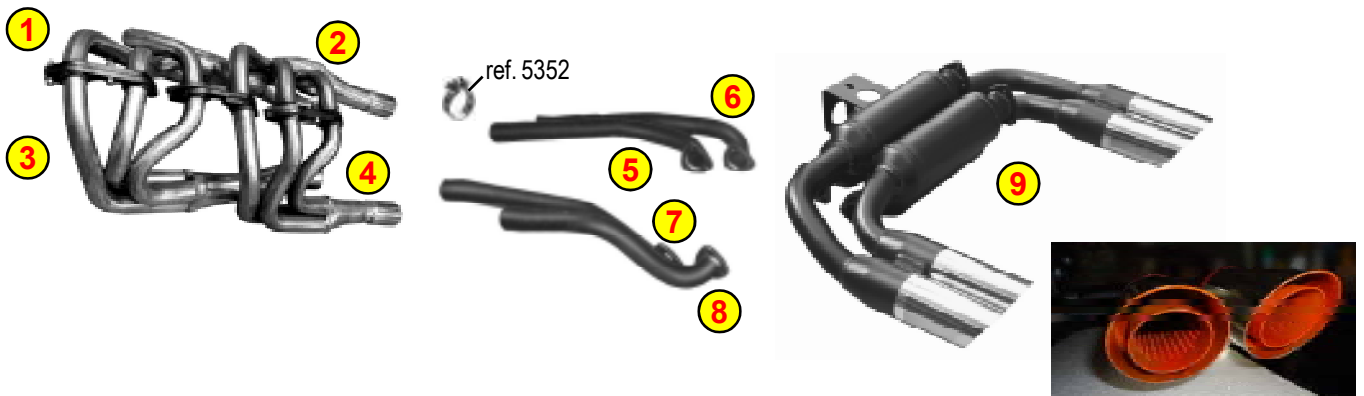

Note: COUNTACH LP400S & 5000S

** E' possibile montare questo silenziatore utilizzando assieme il kit tubi (ref. LM 1724 + LM 1734 + LM 1726 + LM 1736)

** You must install the inter pipes kit (ref. LM 1724 + LM 1734 + LM 1726 + LM 1736) along with the silencer



COUNTACH LP 400 (73>77)

1) Collettore Ant.Dx / Front Manifolds R/h	004410684	ref. LM 1721
2) Collettore Post.Dx / Rear Manifolds R/h	004410685	ref. LM 1722
3) Collettore Ant.Sx / Front Manifolds L/h	004410682	ref. LM 1731
4) Collettore Post.Sx / Rear Manifolds L/h	004410683	ref. LM 1732
5) Tubo Intermedio ant-dx / Inter Pipes (front-r/h)	---	ref. LM 1724
6) Tubo Intermedio post-dx / Inter Pipes (rear r/h)	---	ref. LM 1726
7) Tubo Intermedio ant-sx / Inter Pipes (front-l/h)	---	ref. LM 1734
8) Tubo Intermedio post-sx / Inter Pipes (rear l/h)	---	ref. LM 1736
9) Silenziatore / Silencer	004411350	ref. LM 1727

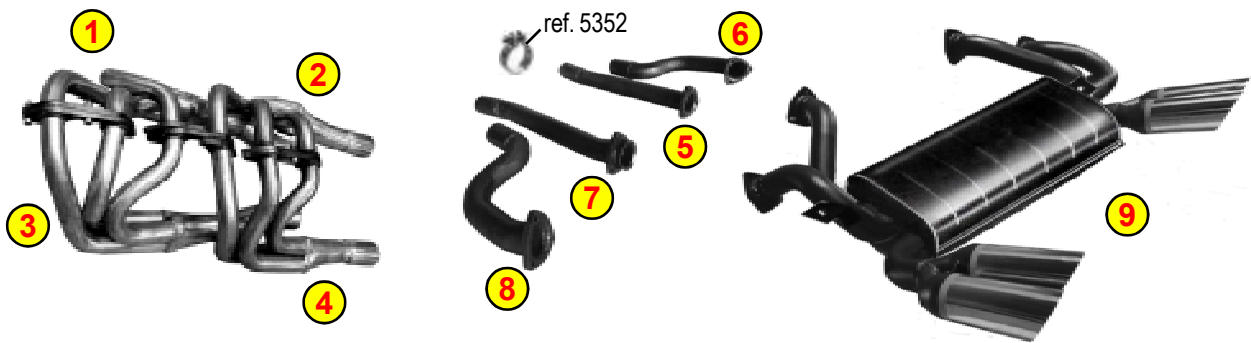

VEDI NOTA PRECEDENTE (sopra)
SEE PREVIOUS NOTE (above)



COUNTACH LP 400 S (78>82)
COUNTACH LP 5000 S (82>85)

1) Collettore Ant.Dx / Front Manifolds R/h	004410684	ref. LM 1721
2) Collettore Post.Dx / Rear Manifolds R/h	004410685	ref. LM 1722
3) Collettore Ant.Sx / Front Manifolds L/h	004410682	ref. LM 1731
4) Collettore Post.Sx / Rear Manifolds L/h	004410683	ref. LM 1732
5) Tubo Intermedio ant-dx / Inter Pipes (front-r/h)	004412715	ref. LM 1824
6) Tubo Intermedio post-dx / Inter Pipes (rear r/h)	004412716	ref. LM 1826
7) Tubo Intermedio ant-sx / Inter Pipes (front-l/h)	004412714	ref. LM 1834
8) Tubo Intermedio post-sx / Inter Pipes (rear l/h)	004412717	ref. LM 1836
9) Silenziatore / Silencer	004412718-4420093	ref. LM 1827

LAMBORGHINI: countach 5000 4 valvole - 25°

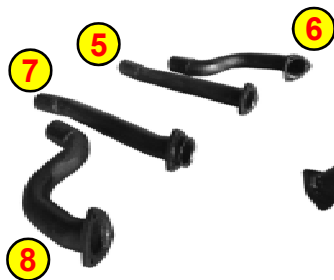
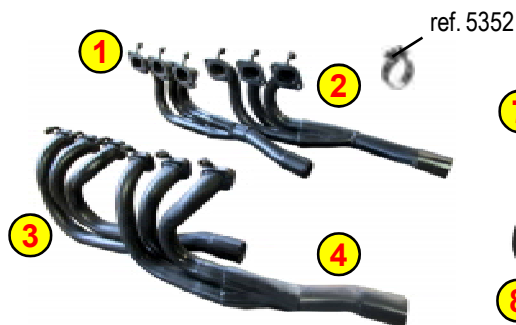

COUNTACH 5000 4valvole (85>88)

- | | | |
|---|-----------|--------------|
| 1) Collettore Ant.Dx / Front Manifolds R/h | 004421868 | ref. LM 2621 |
| 2) Collettore Post.Dx / Rear Manifolds R/h | 004421869 | ref. LM 2622 |
| 3) Collettore Ant.Sx / Front Manifolds L/h | 004421866 | ref. LM 2631 |
| 4) Collettore Post.Sx / Rear Manifolds L/h | 004421867 | ref. LM 2632 |
| 5) Tubo Intermedio ant-dx / Inter Pipes (front-r/h) | 004412715 | ref. LM 1824 |
| 6) Tubo Intermedio post-dx / Inter Pipes (rear r/h) | 004412716 | ref. LM 1826 |
| 7) Tubo Intermedio ant-sx / Inter Pipes (front-l/h) | 004412714 | ref. LM 1834 |
| 8) Tubo Intermedio post-sx / Inter Pipes (rear l/h) | 004412717 | ref. LM 1836 |
| 9) Silenziatore / Silencer | 004421953 | ref. LM 1827 |

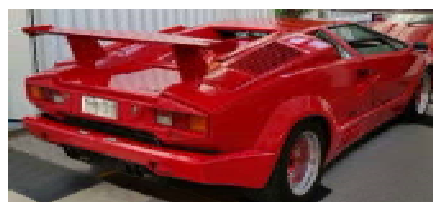
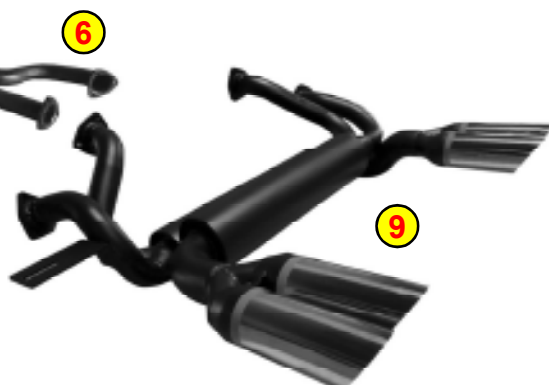
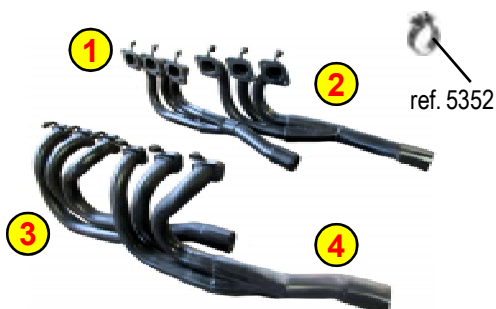

COUNTACH 25° Anniversario Europa (88>90)

- | | | |
|---|-----------|--------------|
| 1) Collettore Ant.Dx / Front Manifolds R/h | 004421868 | ref. LM 2621 |
| 2) Collettore Post.Dx / Rear Manifolds R/h | 004421869 | ref. LM 2622 |
| 3) Collettore Ant.Sx / Front Manifolds L/h | 004421866 | ref. LM 2631 |
| 4) Collettore Post.Sx / Rear Manifolds L/h | 004421867 | ref. LM 2632 |
| 5) Tubo Intermedio ant-dx / Inter Pipes (front-r/h) | 004428338 | ref. LM 2624 |
| 6) Tubo Intermedio post-dx / Inter Pipes (rear r/h) | 004428339 | ref. LM 2626 |
| 7) Tubo Intermedio ant-sx / Inter Pipes (front-l/h) | 004428340 | ref. LM 2634 |
| 8) Tubo Intermedio post-sx / Inter Pipes (rear l/h) | 004428341 | ref. LM 2636 |
| 9) Silenziatore / Silencer | 004428474 | ref. LM 2620 |

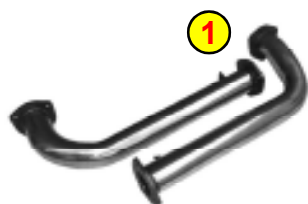

COUNTACH 4v Catalizzata (88>90)
COUNTACH 25° Anniversario Catalizzata (88>90)

- | | | |
|--|-------------|--------------|
| 1) Gruppo Tubi Sost. Cat. / Kit Test Pipes | (004422177) | ref. LM 2644 |
| 2) Silenziatore / Silencer | 004422181 | ref. LM 2640 |

LAMBORGHINI: diablo

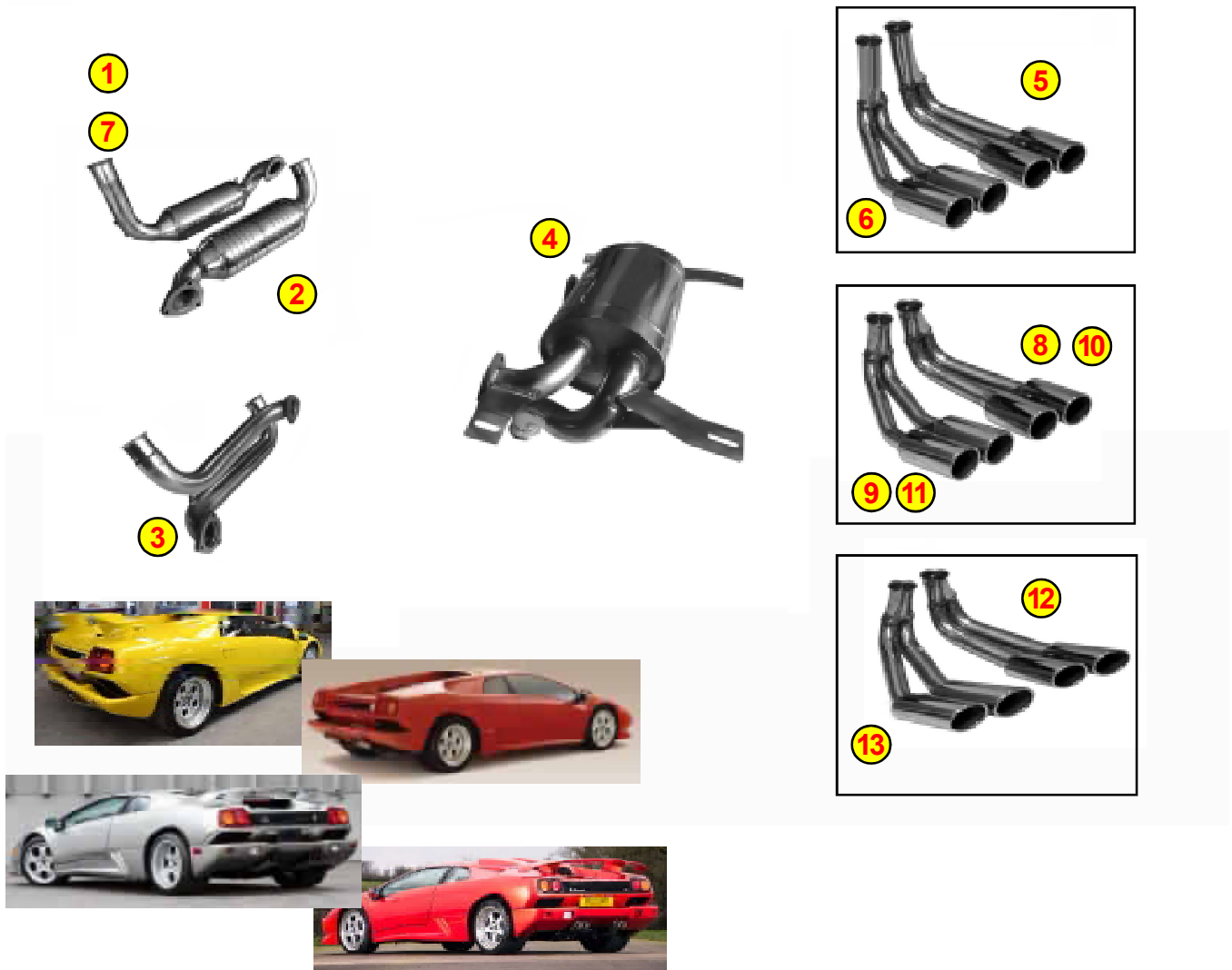

Diablo (90>6/92) > ch 12710

1) Catalizzatore Destro / R/h C.Converter	004431146	ref. LM 4203
2) Catalizzatore Sinistro / L/h C.Converter	004431143	ref. LM 4213
3) Coppia Sost. Cat (dx+sx) / Test Pipes (R/H+L/h)	----	ref. LM 4286
4) Silenziatore / Silencer	004430979	ref. LM 4220
5) Terminale Destro (Tondo) / R/h Rear Pipes (Round)	004432236/31308	ref. LM 4208
6) Terminale Sinistro (Tondo) / L/h Reat Pipes (Round)	004432235/31307	ref. LM 4218

**Diablo (6/92>94) ch 12711>
Diablo VT (93>99)**

7) Catalizzatore Destro (+ cm 1,5) / R/h C.Converter	004403565	ref. LM 4243
2) Catalizzatore Sinistro / L/h C.Converter	004403566	ref. LM 4213
3) Coppia Sost. Cat (dx+sx) / Test Pipes (R/H+L/h)	----	ref. LM 4286
4) Silenziatore / Silencer	004430979	ref. LM 4220
8) Terminale Destro (Tondo) / R/h Rear Pipes (Round)	004432726	ref. LM 4268
9) Terminale Sinistro (Tondo) / L/h Reat Pipes (Round)	004432725	ref. LM 4278

Diablo SE (93)

7) Catalizzatore Destro (+ cm 1,5) / R/h C.Converter	004403565	ref. LM 4243
2) Catalizzatore Sinistro / L/h C.Converter	004403566	ref. LM 4213
3) Coppia Sost. Cat (dx+sx) / Test Pipes (R/H+L/h)	----	ref. LM 4286
4) Silenziatore / Silencer	004430979	ref. LM 4220
10) Terminale Destro (Tondo) / R/h Rear Pipes (Round)	004435548	ref. LM 4228
11) Terminale Sinistro (Tondo) / L/h Rear Pipes (Round)	004435547	ref. LM 4238

Diablo SV (95>99)

7) Catalizzatore Destro (+ cm 1,5) / R/h C.Converter	004403565	ref. LM 4243
2) Catalizzatore Sinistro / L/h C.Converter	004403566	ref. LM 4213
3) Coppia Sost. Cat (dx+sx) / Test Pipes (R/H+L/h)	----	ref. LM 4286
4) Silenziatore / Silencer	004430979	ref. LM 4220
12) Terminale Destro (Ovali) / Rear Pipes (Oval)	0044003943	ref. LM 4288
13) Terminale Sinistro (Ovali) / Rear Pipes (Oval)	0044003942	ref. LM 4298

LAMBORGHINI: espada - islero

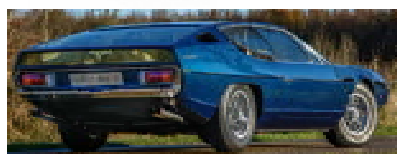
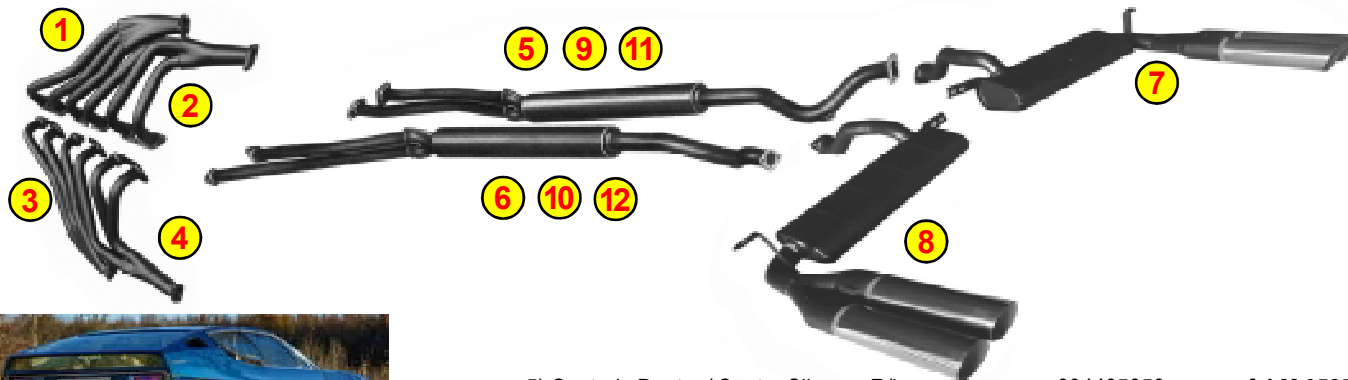

Espada Coupé 1° S (> car 750) (68>71)

5) Centrale Destro / Centre Silencer R/h	004405050	ref. LM 0525
6) Centrale Sinistro / Centre Silencer L/h	004405051	ref. LM 0535
7) Posteriore Destro / Rear Silencer R/h	004405052	ref. LM 0527
8) Posteriore Sinistro / Rear Silencer L/h	004405053	ref. LM 0537

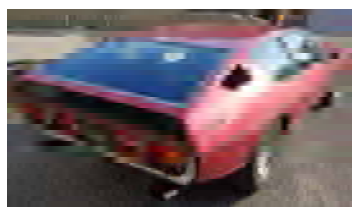

Espada 400 GT 2° Serie (71>74)
Espada 3° Serie (74>78)

1) Collettore Ant.Dx / Front Manifolds R/h	004405045	ref. LM 0621
2) Collettore Post.Dx / Rear Manifolds R/h (Manual)	004405047	ref. LM 0622
3) Collettore Ant.Sx / Front Manifolds L/h	004405046	ref. LM 0631
4) Collettore Post.Sx / Rear Manifolds L/h (Manual)	004405048	ref. LM 0632
9) Centrale Destro / Centre Silencer R/h (Manual)	004409462	ref. LM 0625
10) Centrale Sinistro / Centre Silencer L/h (Manual)	004409463	ref. LM 0635
11) Centrale Destro / Centre Silencer R/h (Autom.)	004410678	ref. LM 0725
12) Centrale Sinistro / Centre Silencer L/h (Autom.)	004410679	ref. LM 0735
7) Posteriore Destro / Rear Silencer R/h	004405052	ref. LM 0527
8) Posteriore Sinistro / Rear Silencer L/h	004405053	ref. LM 0537

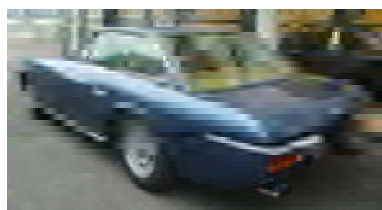
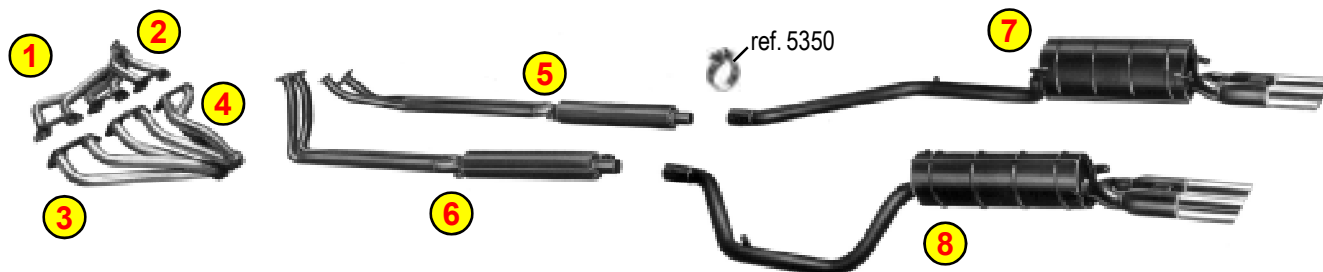

Islero 400 GT 2+2 (1968)

1) Collettore Ant.Dx / Front Manifolds R/h	MT 01793	ref. LM 0201
2) Collettore Post.Dx / Rear Manifolds R/h	MT 03217	ref. LM 0202
3) Collettore Ant.Sx / Front Manifolds L/h	MT 01439	ref. LM 0211
4) Collettore Post.Sx / Rear Manifolds L/h	MT 03218	ref. LM 0212
5) Centrale Destro / Centre Silencer R/h	CM 03198	ref. LM 0225
6) Centrale Sinistro / Centre Silencer L/h	CM 03197	ref. LM 0235
7) Posteriore Destro / Rear Silencer R/h	---	ref. LM 0327
8) Posteriore Sinistro / Rear Silencer L/h	---	ref. LM 0337

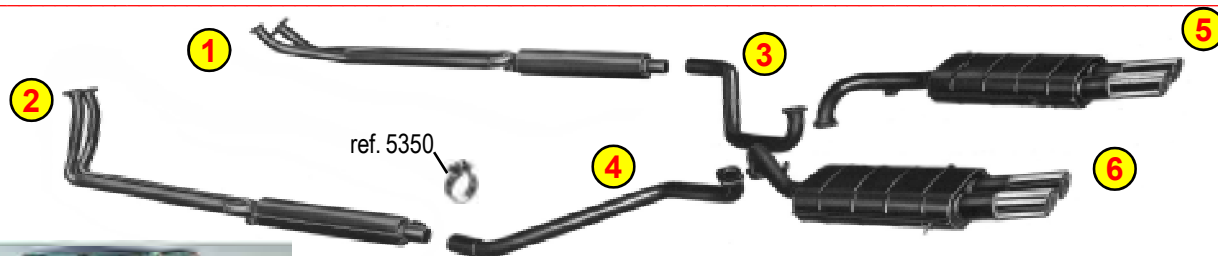

Islero 400 GTS 2+2 (1969)

1) Centrale Destro / Centre Silencer R/h	---	ref. LM 0425
2) Centrale Sinistro / Centre Silencer L/h	---	ref. LM 0435
3) Tubo intermedio Destro / Centre Pipe R/h	---	ref. LM 0426
4) Tubo intermedio Sinistro / Centre Pipe L/h	---	ref. LM 0436
5) Posteriore Destro / Rear Silencer R/h	---	ref. LM 0427
6) Posteriore Sinistro / Rear Silencer L/h	---	ref. LM 0437

LAMBORGHINI: jalpa - jarama



Jalpa P350 (81>88)

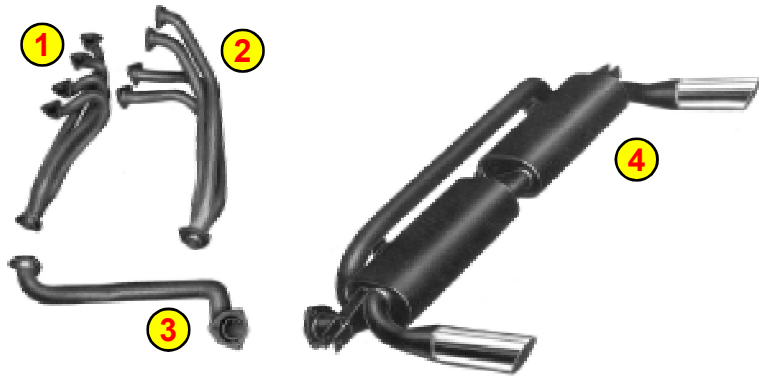

- | | | |
|---|-----------|--------------|
| 1) Collettore Anteriore / Front Manifold | 004410986 | ref. LM 1421 |
| 2) Collettore Posteriore / Rear Manifold | 004410988 | ref. LM 1431 |
| 3) Tubo Intermedio / Inter Pipe | 004410987 | ref. LM 1424 |
| 4) Silenziatore / Silencer | 004410945 | ref. LM 1427 |
| 5) Gruppo Collettori / Manifolds (R/h+L/h) - CH + USA --- | | ref. LM 2181 |

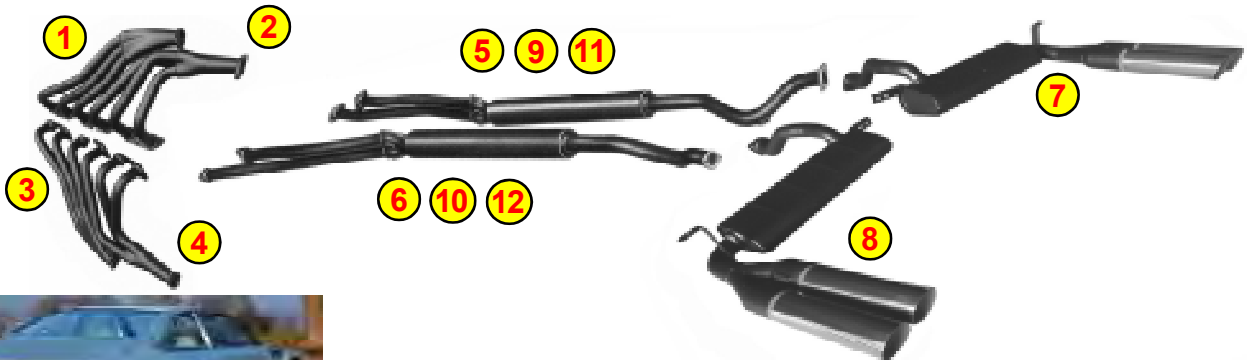

Jarama Coupé 2+2 (1° Serie -> car nr.100 70>71)

- | | | |
|--|-----------|--------------|
| 5) Centrale Destro / Centre Silencer R/h | --- | ref. LM 0825 |
| 6) Centrale Sinistro / Centre Silencer L/h | --- | ref. LM 0835 |
| 7) Posteriore Destro / Rear Silencer R/h | 004405052 | ref. LM 0527 |
| 8) Posteriore Sinistro / Rear Silencer L/h | 004405053 | ref. LM 0537 |



Jarama GT 400 2+2 (2° Serie) 71>73

- | | | |
|---|-----------|--------------|
| 1) Collettore Ant.Dx / Front Manifolds R/h | 004405045 | ref. LM 0621 |
| 2) Collettore Post.Dx / Rear Manifolds R/h | 004405047 | ref. LM 0622 |
| 3) Collettore Ant.Sx / Front Manifolds L/h | 004405046 | ref. LM 0631 |
| 4) Collettore Post.Sx / Rear Manifolds L/h | 004405048 | ref. LM 0632 |
| 9) Centrale Destro / Centre Silencer R/h (Manual) | 004407548 | ref. LM 0925 |
| 10) Centrale Sinistro / Centre Silencer L/h (Manual) | 004407547 | ref. LM 0935 |
| 11) Centrale Destro / Centre Silencer R/h (Automatic) | --- | ref. LM 1025 |
| 12) Centrale Sinistro / Centre Silencer L/h (Automatic) | --- | ref. LM 1035 |
| 7) Posteriore Destro / Rear Silencer R/h | 004405052 | ref. LM 0527 |
| 8) Posteriore Sinistro / Rear Silencer L/h | 004405053 | ref. LM 0537 |



Jarama GTS 400 2+2 (72>76)

- | | | |
|--|-----------|--------------|
| 1) Collettore Ant.Dx / Front Manifolds R/h | 004405045 | ref. LM 0621 |
| 2) Collettore Post.Dx / Rear Manifolds R/h | 004405047 | ref. LM 0622 |
| 3) Collettore Ant.Sx / Front Manifolds L/h | 004405046 | ref. LM 0631 |
| 4) Collettore Post.Sx / Rear Manifolds L/h | 004405048 | ref. LM 0632 |
| 5) Centrale Destro / Centre Silencer R/h | 004409145 | ref. LM 1125 |
| 6) Centrale Sinistro / Centre Silencer L/h | 004409146 | ref. LM 1135 |
| 7) Posteriore Destro / Rear Silencer R/h | 004409147 | ref. LM 1127 |
| 8) Posteriore Sinistro / Rear Silencer L/h | 004409148 | ref. LM 1137 |

LAMBORGHINI: gallardo - Im002 - murcielago

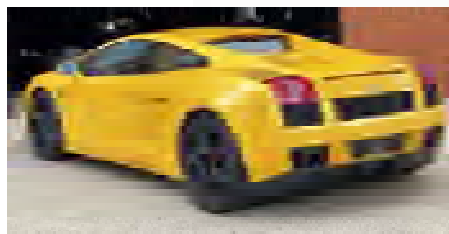
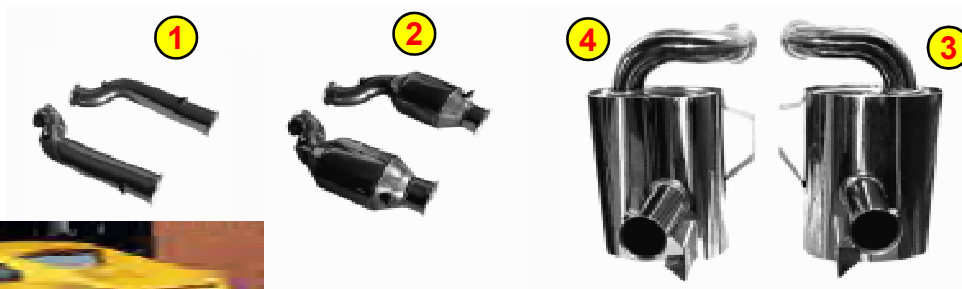

Gallardo - SE (03>08)

- | | | |
|--|-----------------|--------------|
| 1) Gruppo Tubi Sost. Cat / Test Pipes (R/h+L/h) | --- | ref. LM 4184 |
| 2) Gruppo Catalizzatori Sport / Sport C.Converters (R/h+L/h) | 07L251718+7 | ref. LM 4183 |
| 3) Silenziatori Sport Destro / R/h Sport Silencer | 07L251052A+238A | ref. LM 4127 |
| 4) Silenziatori Sport Sinistro / L/h Sport Silencer | 07L251051A+237A | ref. LM 4137 |

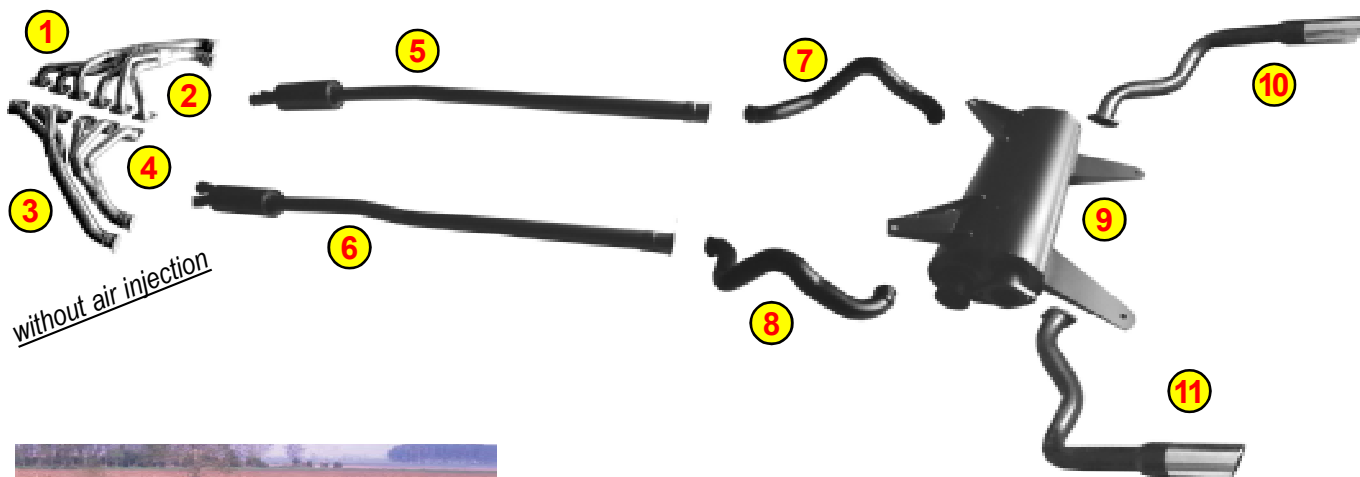

LM 002 (86>93)

- | | | |
|---|-------------------|--------------|
| 1) Collettore Anteriore Dx / R/h Front Manifold | 004423568 | ref. LM 3021 |
| 2) Collettore Posteriore Dx / R/h Rear Manifold | 004423569 | ref. LM 3022 |
| 3) Collettore Anteriore Sx / L/h Front Manifold | 004423566 | ref. LM 3031 |
| 4) Collettore Posteriore Sx / L/h Rear Manifold | 004423567 | ref. LM 3032 |
| 5) Silenziatore Anteriore Dx / R/h Front Silencer | 004424972 | ref. LM 3003 |
| 6) Silenziatore Anteriore Sx / L/h Front Silencer | 004424973 | ref. LM 3013 |
| 7) Tubo Centrale Dx / R/h Centre Pipe | 004423557 | ref. LM 3004 |
| 8) Tubo Centrale Sx / L/h Centre Pipe | 004423558 | ref. LM 3014 |
| 9) Silenziatore / Sport Silencer | 004423377 | ref. LM 3025 |
| 10) Tubo Posteriore Dx / R/h Rear Pipe | 004423559/4223889 | ref. LM 3008 |
| 11) Tubo Posteriore Sx / L/h Rear Pipe | 004423560 | ref. LM 3018 |



Murcielago (01>10)

- | | | |
|---|---------------|--------------|
| 1) Catalizzatori Anteriori Sport / Front C.Converters (R/h-L/h) | 0044008057+61 | ref. LM 4083 |
| 2) Silenziatore Sport / Sport Silencer | 07M251051 | ref. LM 4020 |

LAMBORGHINI: miura

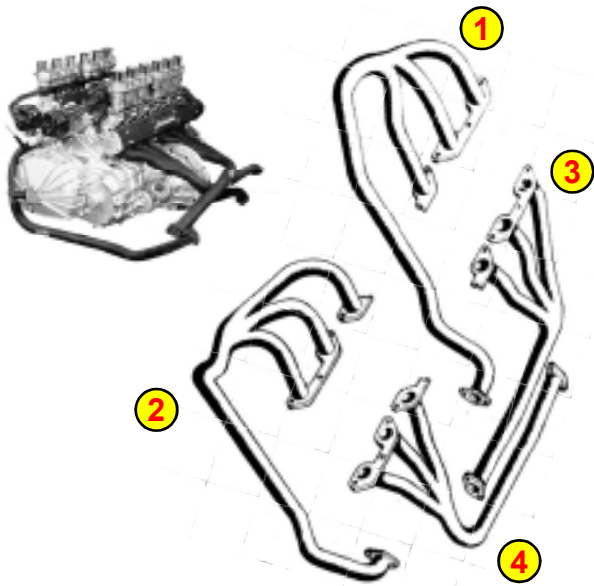

Miura P400 65>71
Miura P400 S 68> 71

- | | | |
|---|-------------|--------------|
| 1) Collettore Ant Destro / Front R/h Manifold | 004404119 | ref. LM 1501 |
| 2) Collettore Ant Sinistro / Front L/h Manifold | 004404120 | ref. LM 1511 |
| 3) Collettore Post Destro / Rear R/h Manifold | 004404121 | ref. LM 1502 |
| 4) Collettore Post Sinistro / Rear L/h Manifold | 004404122 | ref. LM 1512 |
| 5) Silenziatore / Silencer | 004403928 | ref. LM 1587 |
| 6) Silenziatore stampato / Silencer Pressed Box | (004403928) | ref. LM 1547 |

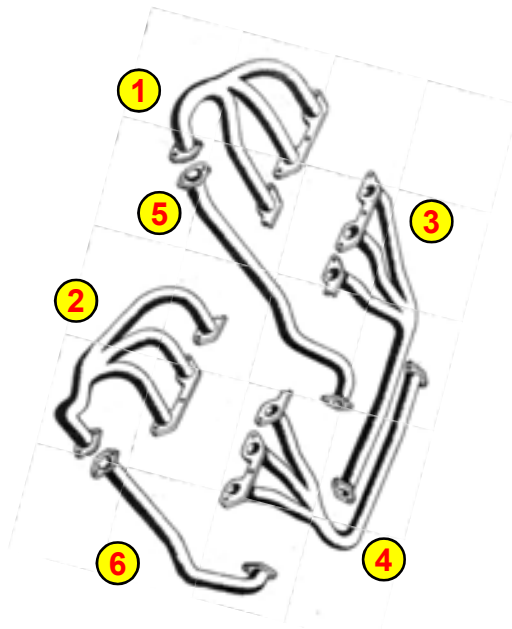

Miura P400 SV 71>73

- | | | |
|---|-----------|--------------|
| 1) Collettore Ant Destro / Front R/h Manifold | 004407809 | ref. LM 1601 |
| 2) Collettore Ant Sinistro / Front L/h Manifold | 004407810 | ref. LM 1611 |
| 3) Collettore Post Destro / Rear R/h Manifold | 004404121 | ref. LM 1502 |
| 4) Collettore Post Sinistro / Rear L/h Manifold | 004404122 | ref. LM 1512 |
| 5) Tubo Intermedio Dx / R/h Inter Pipe | 004408298 | ref. LM 1604 |
| 6) Tubo intermedio Sx / L/h Inter Pipe | 004408299 | ref. LM 1614 |
| 7) Silenziatore / Silencer | 004408297 | ref. LM 1527 |

LAMBORGHINI: urraco

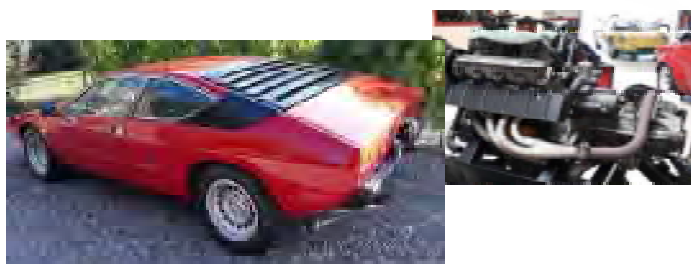

Urraco P200 (74>79)
Urraco P250 (70>79)

- 1) Collettore Anteriore / Front Manifold
- 2) Collettore Posteriore / Rear Manifold
- 3) Tubo Intermedio / Inter Pipe
- 4) Silenziatore / Silencer

004408453 ref. LM 1321
004408454 ref. LM 1331
004408452 ref. LM 1324
004408455 ref. LM 1327

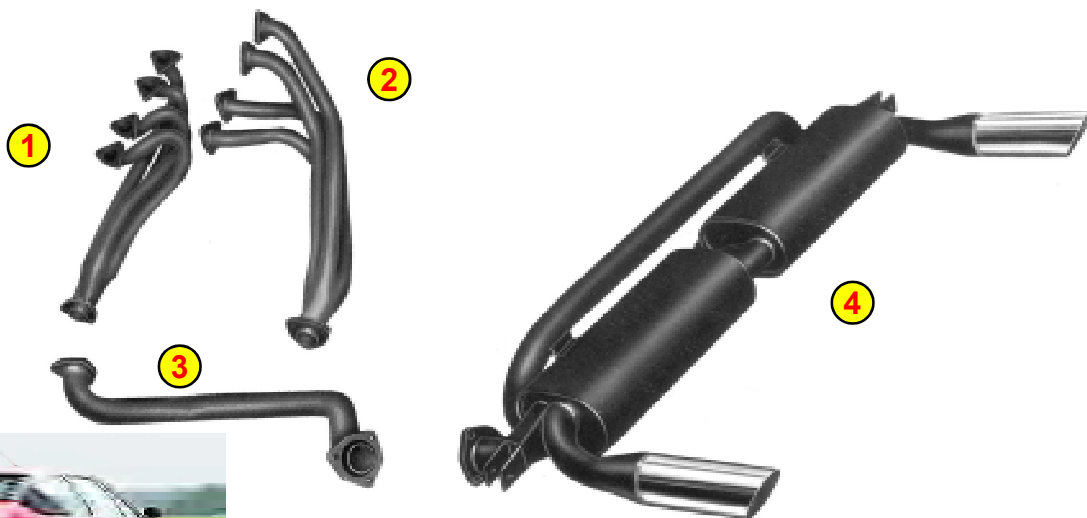

Urraco P300 - 3° Serie(74>79)
Silhouette (76>79)

- 1) Collettore Anteriore / Front Manifold
- 2) Collettore Posteriore / Rear Manifold
- 3) Tubo Intermedio / Inter Pipe
- 4) Silenziatore / Silencer

004410986 ref. LM 1421
004410988 ref. LM 1431
004410987 ref. LM 1424
004410945 ref. LM 1427

LANCIA: beta montecarlo - delta hf - stratos



Beta Montecarlo 75>82

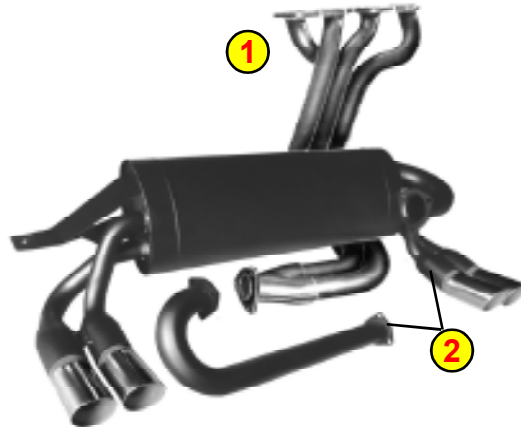

- | | | |
|--|-----|--------------|
| 1) Collettore / Manifold | --- | ref. LN 2281 |
| 2) Silenziatore e tubo / Silencer & Inter Pipe | --- | ref. LN 2220 |



Delta HF Integrale 4WD - 8v 86>91

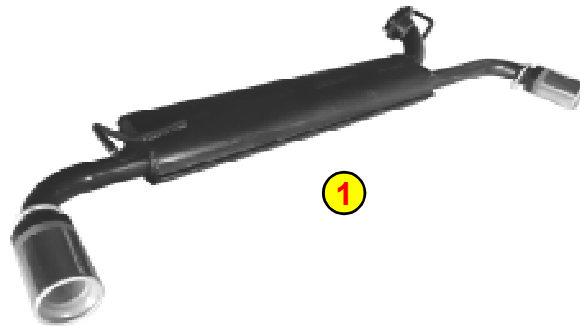

- | | | |
|--|-----|--------------|
| 1) Silenziatore Posteriore /RearSilencer | --- | ref. LN 4187 |
|--|-----|--------------|



Dekta HF 4WD 16v Evoluzione 91>94



- | | | |
|--|-----|--------------|
| 1) Silenziatore Posteriore /RearSilencer | --- | ref. LN 4137 |
|--|-----|--------------|



Stratos 73>76

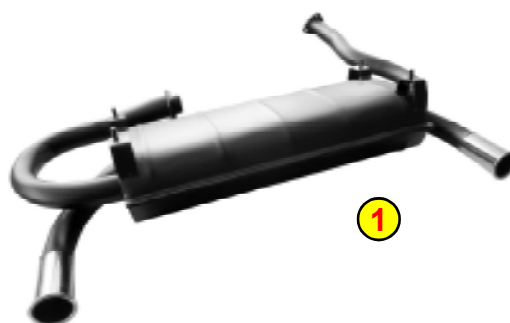

- | | | |
|--|-----|--------------|
| 1) Silenziatore Posteriore /RearSilencer | --- | ref. LN 4220 |
|--|-----|--------------|

MASERATI: 3500 gt - biturbo - karif

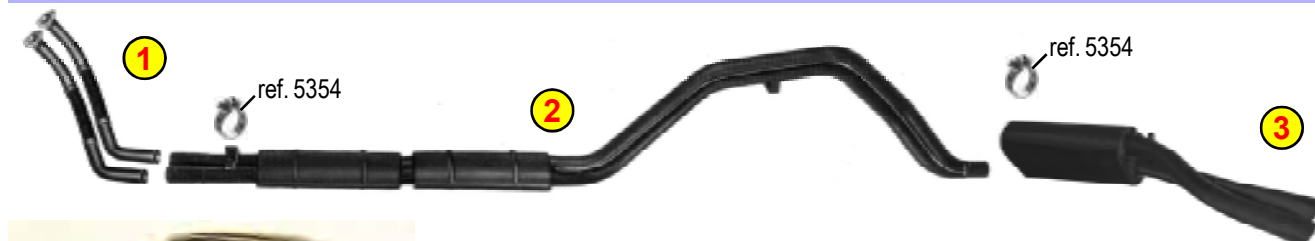

3500 GT Coupé 1° Serie (57)

1) Gruppo Tubi anteriori / Front Pipes R/h+L/h	50999+51000	ref. MA 0184
2) Silenziatore Centrale / Centre Silencer	(47341)	ref. MA 0125
3) Silenziatore Posteriore / Rear Silencer	(47341)	ref. MA 0107



3500 GT - GTI Coupé (Touring, Allemano) 57>64
3500 GT - GTI Spider (Vignale) 57>64

1) Gruppo Tubi anteriori / Front Pipes R/h+L/h	50999+51000	ref. MA 0184
2) Silenziatore Centrale / Centre Silencer	---	ref. MA 0125
3) Silenziatore Posteriore / Rear Silencer (Coupé)	---	ref. MA 0127
4) Silenziatore Posteriore / Rear Silencer (Spider)	---	ref. MA 0137



Biturbo 420 - 425 85>88



1) Silenziatore Posteriore / Rear Silencer	329020109	ref. MA 2027
--	-----------	--------------



Biturbo 2.0/2.8 Si 88
Biturbo Spider 88
Karif 88



1) Silenziatore Posteriore Dx / Rear Silencer R/h	---	ref. MA 2707
2) Silenziatore Posteriore Dx / Rear Silencer R/h	---	ref. MA 2717

Biturbo Si + Racing + Spider + 4V 89>
222 E - 224 - 224 Si - Karif 89>

3) Silenziatore Posteriore Dx / Rear Silencer R/h	319053110	ref. MA 3107
4) Silenziatore Posteriore Dx / Rear Silencer R/h	319053109	ref. MA 3117

"NUOVO PARAURTI"

MASERATI: bora - ghibli

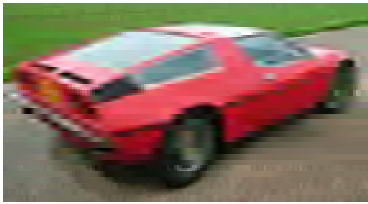

Bora 4.7 - 4.9 71>78

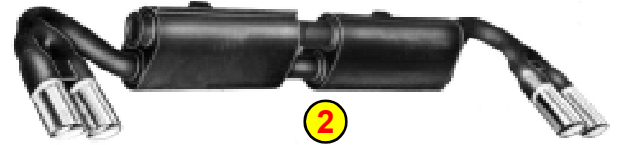
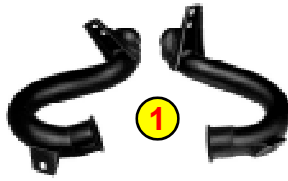

- 1) Gruppo Tubi Anteriori / Front Pipes R/h+L/h
- 2) Silenziatore / Silencer

CM-68470+495 ref. MA 0924
 CM-68454 ref. MA 0920



Ghibli Coupé 4.7 (115) 66>73

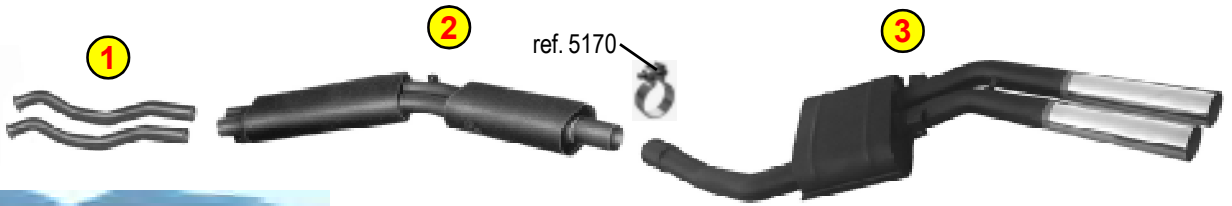

- Gruppo Tubi Anteriori / Front Pipes R/h+L/h
- Silenziatore Centrale / Centre Silencer
- Silenziatore Posteriore / Rear Silencer

CM-64329+330 ref. MA 0782
 CM-64186 ref. MA 0725
 CM-64187 ref. MA 0727



Ghibli Coupé SS 4.9/5.0 70>73

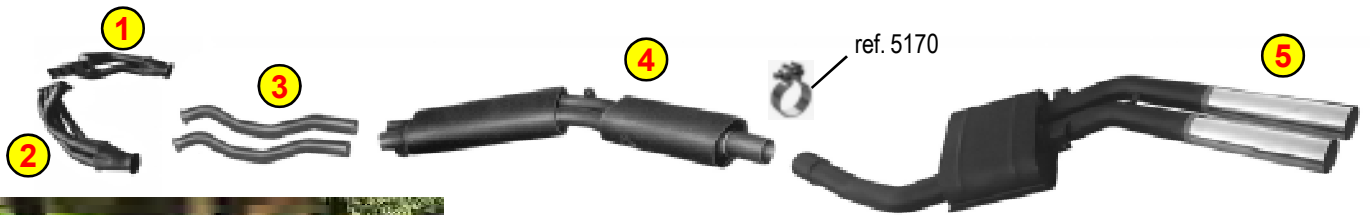

- 1) Collettori Destro / R/h Manifold
- 2) Collettori Destro / L/h Manifold
- 3) Gruppo Tubi Anteriori / Front Pipes R/h+L/h
- 4) Silenziatore Centrale / Centre Silencer
- 5) Silenziatore Posteriore / Rear Silencer

MT-64356 ref. MA 1421
 MT-64357 ref. MA 1431
 CM-64329+330 ref. MA 0782
 CM-65921 ref. MA 1425
 CM-65922 ref. MA 0727



Ghibli Biturbo 2000 - 2800 92>93



- 1) Posteriore Destro / Rear Silencer R/h
- 2) Posteriore Sinistro / Rear Silencer L/h

369000110 ref. MA 4607
 369000109 ref. MA 4617

Ghibli Biturbo 2000 - 2800 (ABS) 94>97

- 3) Posteriore Destro / Rear Silencer R/h
- 4) Posteriore Sinistro / Rear Silencer L/h

369003110 ref. MA 4807
 369003109 ref. MA 4817

MASERATI: khamsin - kyalami - indy



Khamsin 73>82



- 1) Posteriore Destro / Rear Silencer R/h
- 2) Posteriore Sinistro / Rear Silencer L/h

CM-79993
CM-79819

ref. MA 2227
ref. MA 2237



Kyalami 4.2 76>83
Kyalami 4.9 78>83



- 1) Silenziatore Posteriore / Rear Silencer

329303700

ref. MA 1127



Indy 4.2 - 4.7 Coupé 69>76

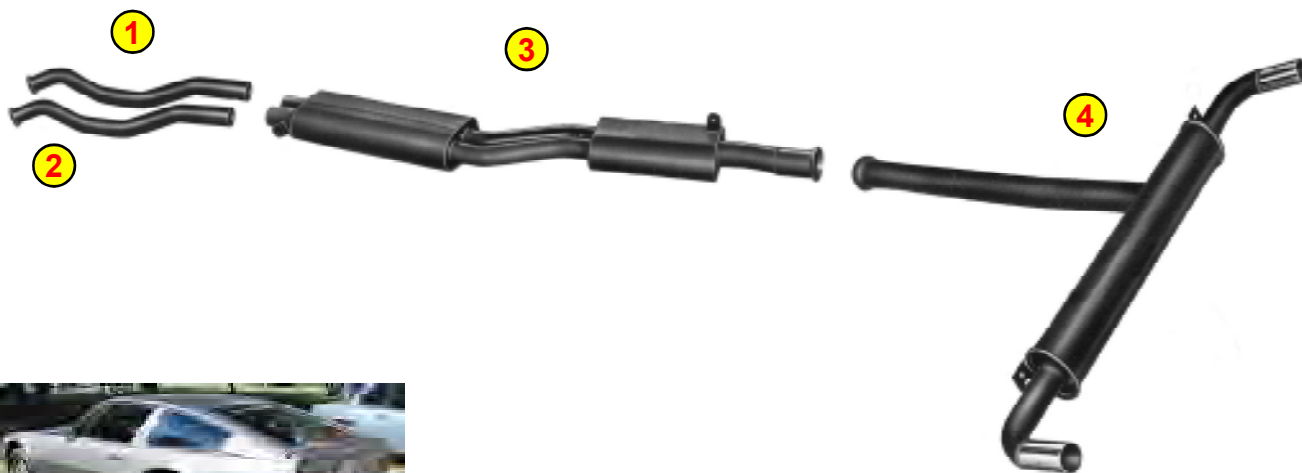

- 1) Tubo Anteriore Destro / Front Pipe R/h
- 2) Tubo Anteriore Sinistro / Front Pipe L/h
- 3) Silenziatore Centrale / Centre Silencer
- 4) Silenziatore Posteriore / Rear Silencer

CM-67020
CM-69186
CM-72865
CM-72980

ref. MA 0822
ref. MA 0832
ref. MA 0825
ref. MA 0827

Indy 4.9 Coupé 73>76

- 2) Tubi Anter.Dx e Sx / Front Pipe R/h & L/h (2 pcs req)
- 3) Silenziatore Centrale / Centre Silencer
- 4) Silenziatore Posteriore / Rear Silencer

CM-72861
CM-72865
CM-72980

ref. MA 0832
ref. MA 0825
ref. MA 0827

MASERATI: merak - mexico



Merak 2.0 GT 76>83

- | | | |
|---|-------------|--------------|
| 1) Collettore Destro / R/h Manifold | CM-83369 | ref. MA 1021 |
| 2) Collettore Sinistro / L/h Manifold | CM-83368 | ref. MA 1031 |
| 3) Gruppo Anteriori / Front Silencers (R/h+L/h) | CM-82676+77 | ref. MA 1225 |
| 4) Silenziatore / Silencer | CM-826675 | ref. MA 1020 |



Merak 3.0 GT/SS 72>83

- | | | |
|--|-------------|--------------|
| 1) Collettore Destro / R/h Manifold | CM-83369 | ref. MA 1021 |
| 2) Collettore Sinistro / L/h Manifold | CM-83368 | ref. MA 1031 |
| 3) Gruppo Tubi Anteriori / Front Pipes (R/h+L/h) | CM-82676+77 | ref. MA 1025 |
| 4) Silenziatore / Silencer | CM-826675 | ref. MA 1020 |

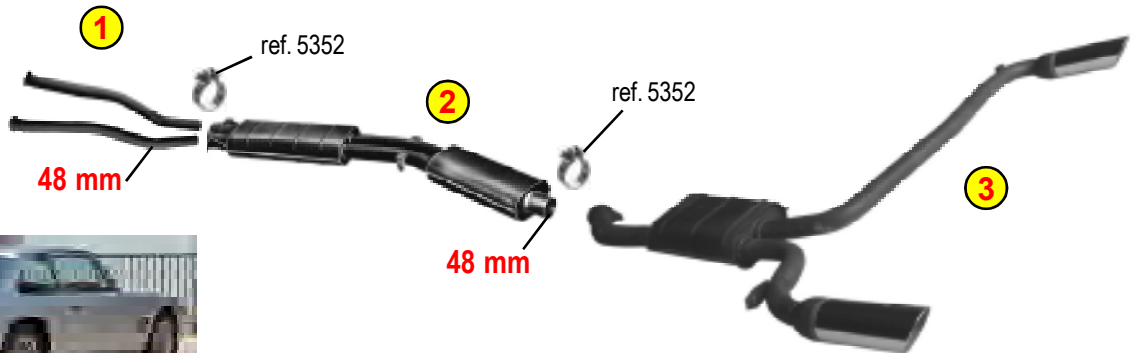

Mexico 4.2 - 4.7 Coupé 1° Serie 66>70

- | | | |
|--|-------------|--------------|
| 1) Gruppo Tubi Anteriori / Front Pipes R/h+L/h | CM-69962+63 | ref. MA 0582 |
| 2) Silenziatore Centrale / Centre Silencer | CM-64300 | ref. MA 0525 |
| 3) Silenziatore Posteriore / Rear Silencer | CM-64320 | ref. MA 0527 |

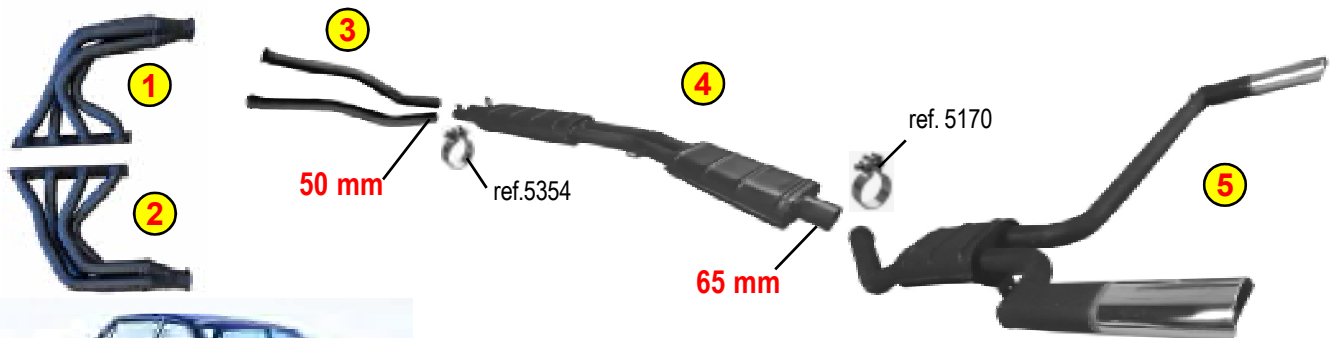

Mexico 4.2 - 4.7 Coupé 2° Serie 70>73

- | | | |
|--|-------------|--------------|
| 1) Collettore Destro / R/h Manifold | CM-68378 | ref. MA 0621 |
| 2) Collettore Sinistro / L/h Manifold | CM-68377 | ref. MA 0631 |
| 3) Gruppo Tubi Anteriori / Front Pipes R/h+L/h | CM-69962+63 | ref. MA 0682 |
| 4) Silenziatore Centrale / Centre Silencer | CM-69951 | ref. MA 0625 |
| 5) Silenziatore Posteriore / Rear Silencer | CM-69956 | ref. MA 0627 |

MASERATI: mistral - quattroporte (107)

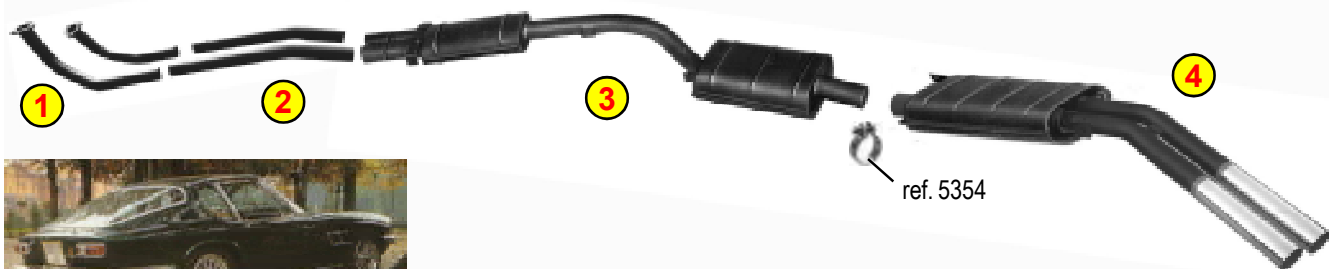

Mistral 3.5 - 3.7 63>66 (109) Coupé > ch 552
Spider > ch 599

- | | | |
|--|-------------|--------------|
| 1) Gruppo Tubi Anteriori / Front Pipes (R/h+L/h) | CM-56591+92 | ref. MA 0322 |
| 2) Gruppo Tubi Centrali / Inter Pipes (R/h+L/h) | CM-56589+90 | ref. MA 0424 |
| 3) Silenziatore Centrale / Centre Silencer | CM-56583 | ref. MA 0425 |
| 4) Silenziatore Posteriore / Rear Silencer | CM-56608 | ref. MA 0327 |

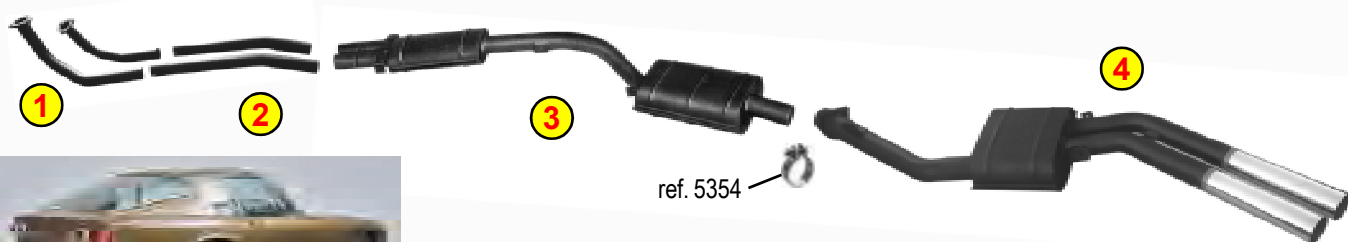

Mistral 3.7 - 4.0 66>70 (109/A) Coupé ch 554>
Spider ch 601>

- | | | |
|--|-------------|--------------|
| 1) Gruppo Tubi Anteriori / Front Pipes (R/h+L/h) | CM61428+29 | ref. MA 0422 |
| 2) Gruppo Tubi Centrali / Inter Pipes (R/h+L/h) | CM-56589+90 | ref. MA 0424 |
| 3) Silenziatore Centrale / Centre Silencer | CM-56583 | ref. MA 0425 |
| 4) Silenziatore Posteriore / Rear Silencer | CM-61425 | ref. MA 0427 |



Quattroporte 1° Serie (107) 63>66
"Ponte De Dion"

- | | | |
|--|-------------|--------------|
| 1) Gruppo Tubi Anteriori / Front Pipes (R/h+L/h) | CM-56673+70 | ref. MA 0292 |
| 2) Silenziatore Anteriore / Front Silencer | CM-56651 | ref. MA 0293 |
| 3) Tubo Intermedio / Inter Pipe | CM-56839 | ref. MA 0294 |
| 4) Tubo Centrale / Centre Pipe | CM-56684 | ref. MA 0296 |
| 5) Silenziatore Posteriore / Rear Silencer | CM-56696 | ref. MA 0297 |



Quattroporte 2° Serie (107/A) 66>70
"Ponte Rigido"

- | | | |
|--|----------|--------------|
| 1) Gruppo Tubi Anteriori / Front Pipes (R/h+L/h) | --- | ref. MA 0224 |
| 2) Silenziatore Centrale / Centre Silencer | CM-62643 | ref. MA 0225 |
| 3) Silenziatore Posteriore / Rear Silencer | CM-62929 | ref. MA 0227 |

MASERATI: quattroporte - sebring

1) Centrale Destro / Centre Silencer R/h	330303400	ref. MA 1525
2) Centrale Sinistro / Centre Silencer L/h	330303500	ref. MA 1535
3) Posteriore / Rear Silencer	330303700	ref. MA 1507

1) Posteriore Destro / Rear Silencer R/h	379000110	ref. MA 5007
2) Posteriore Sinistro / Rear Silencer L/h	379000109	ref. MA 5017

3) Posteriore Destro / Rear Silencer R/h	379005110	ref. MA 5107
4) Posteriore Sinistro / Rear Silencer L/h	379005109	ref. MA 5117

1) Posteriore Destro / Rear Silencer R/h	201253	ref. MA 3927
2) Posteriore Sinistro / Rear Silencer L/h	201254	ref. MA 3937

1) CoppiaTubi Anteriori / Front Pipes Set	---	ref. MA 1781
2) CoppiaTubi Intermedi/ Inter Pipes Set	---	ref. MA 1724
3) Silenziatore Centrale / Centre Silencer	CM-64300	ref. MA 0525
4) Silenziatore Posteriore / Rear Silencer	---	ref. MA 1727

ref. 5352

MASERATI: shamal - gt - granturismo

1
PICTURE NOT AVAILABLE

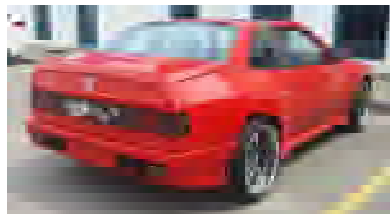
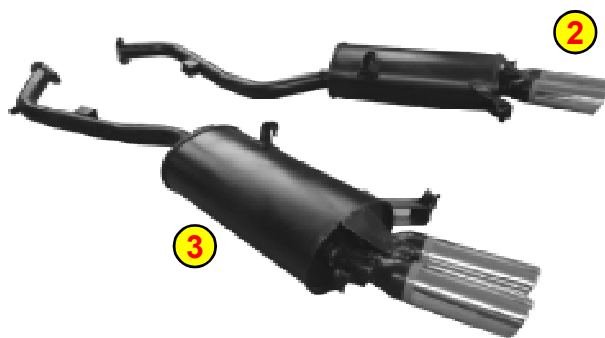

Shamal

- | | | |
|--|-----------|--------------|
| 1) Anteriore (sost. Cat) / Front Silencer | 399050103 | ref. MA 4403 |
| 2) Posteriore Destro / Rear Silencer R/h | 399050110 | ref. MA 4407 |
| 3) Posteriore Sinistro / Rear Silencer L/h | 399050109 | ref. MA 4417 |



Shamal (Svizzera)

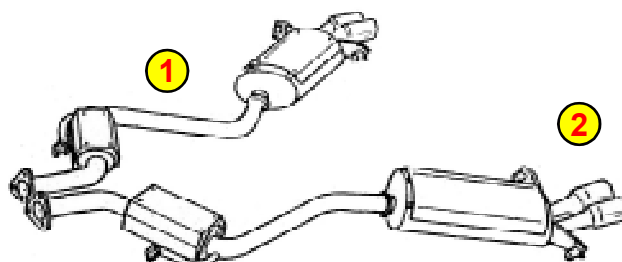

- | | | |
|--|-----------|--------------|
| 1) Posteriore Destro / Rear Silencer R/h | 399050110 | ref. MA 4507 |
| 2) Posteriore Sinistro / Rear Silencer L/h | 399050109 | ref. MA 4517 |



GT 3.2 Coupé & Spider (Turbo) 98>02



- | | | |
|--|-----------|--------------|
| 1) Posteriore Destro / Rear Silencer R/h | 389000110 | ref. MA 4127 |
| 2) Posteriore Sinistro / Rear Silencer L/h | 389000109 | ref. MA 4137 |

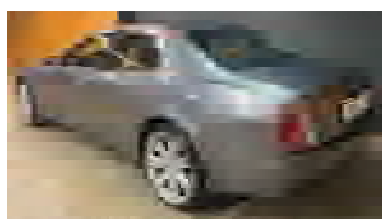

Coupé 4.2 GT & Spider (Aspirato) 02>06



- | | | |
|--|--------|--------------|
| 1) Silenziatore Centrale / Centre Silencer | 187826 | ref. MA 4025 |
| 2) Posteriore Destro / Rear Silencer R/h | 184815 | ref. MA 4027 |
| 3) Posteriore Sinistro / Rear Silencer L/h | 184816 | ref. MA 4037 |



Granturismo 07>

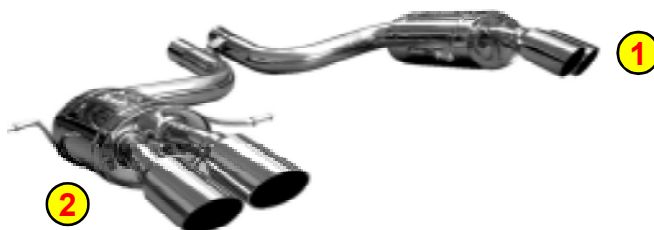

- | | | |
|--|--------|--------------|
| 1) Posteriore Destro / Rear Silencer R/h | 237723 | ref. MA 6127 |
| 2) Posteriore Sinistro / Rear Silencer L/h | 237724 | ref. MA 6137 |

MATRA-SIMCA: bagheera



Bagheera 73>80

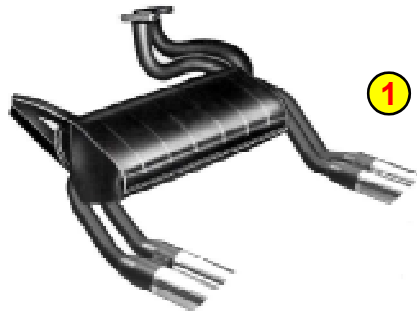

1) Posteriore / Rear Silencer

ref. MT 1820

PORSCHE: 928 - 928S



912 - 1600S (90 Hp) 65>69
365B - 1600 (60/90 Hp) >8/61



1) Posteriore / Rear Silencer

61611101005

ref. PR 0120



928 77>82



1) Posteriore / Rear Silencer

ref. PR 1227



928 S 9/79>7/86



1) Posteriore / Rear Silencer

ref. PR 1527

UNIVERSALI: silencer

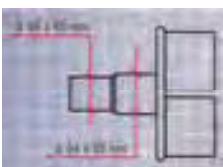

ACCESSORI: terminali "SNAP" - "SNAP" tail trims



Per Tubi (mm)	Ref
40	UN 0399
45	UN 0199
48	UN 0299

ACCESSORI: vari per montaggio - various mounting parts



Ref. **6001**

MASERATI
Piastrina metallica ritegno tiranti
interc. with o.e. 16506-54086



Ref. **6002**

MASERATI
Protezione fori tiranti
interc. with o.e. 54089

ACCESSORI: fascette - clamps



MM	Ref
38	5038
42	5042
45	5045
48	5048
51	5051
54	5054
57	5057
60	5060
69	5069



MM	Ref
38	5138
45	5145
53	5153
55	5155
57	5157
60	5160
63	5163
65	5165
67	5167
70	5170



MM	Ref
43	5243
45	5245
49	5249
52	5252
54	5254



MM	Ref
33	5333
36	5336
40	5340
43	5343
46	5346
48	5348
50	5350
52	5352
54	5354

ACCESSORI: guarnizioni collettori di scarico - manifolds gaskets

<p>Ref. 1001 FERRARI - Dino 206/246 - 308 gt4/gtb/gts/gtbi 2v - Mondial 8 interc. with o.e. 105942-106125-147707</p> 	<p>Ref. 1002 FERRARI - 208 gt4/gtb/gts - 208 Turbo interc. with o.e. 107975-147804-149027</p> 	<p>Ref. 1003 FERRARI - 308 gtbi 4v/gtsi 4v - 328 gtb/gts - Mondial 4v interc. with o.e. 111532-147705</p> 
<p>Ref. 1004 FERRARI - 512 tr - F512m - Testarossa (sx-l/h) interc. with o.e. 146658-124694</p> 	<p>Ref. 1005 FERRARI - 348 - 512tr - F512m - Mondial T - F40 - Testarossa (dx-r/h) interc. with o.e. 138076-124693</p> 	<p>Ref. 1006 FERRARI - 355 - 360 interc. with o.e. 151064</p> 
<p>Ref. 1011 FERRARI - 250 gt - 275 gtb/gts/gtb4 interc. with o.e. 17454</p> 	<p>Ref. 1012 FERRARI - 250 gt - 275 gtb/gts/gtb4 interc. with o.e. 17742</p> 	<p>Ref. 1013 FERRARI - 330 - 365gt 2+2/gtb4/gtc4/gt4 - 400-412-BB365gt4-BB512 interc. with o.e. 20242-102015-147630</p> 
<p>Ref. 1014 FERRARI - 330 - 400 - 412 - 365gt 2+2/gtb4/gtc4/gt4 interc. with o.e. 20276-102017-147631</p> 	<p>Ref. 1015 FERRARI - BB 365 gt4 - BB 512 interc. with o.e. 105595-147641</p> 	

ACCESSORI: guarnizioni silenziatori - exhaust system gaskets

<p>Ref. 2001 FERRARI - Dino 206/246 L/M - 275 gtb/gts - 330 gt 2+2/gtc interc. with o.e. 20268-20449</p> 	<p>Ref. 2002 FERRARI - Dino 246 E - 208 gt4/gtb/gts - 512bb interc. with o.e. 108483-154979</p>  <p>D. 42 mm int</p>	<p>Ref. 2003 FERRARI - 308 GTBi - GTSi USA interc. with o.e. 111693</p>  <p>D. 45 mm int</p>
<p>Ref. 2004 FERRARI - 308 gt4/gtb/gtbi 2v/4v Usa - 328 Usa-Mondial8/3.2/4v Usa - 365 gt4/gt4bb-400-412 - Testarossa interc. with o.e.103377-146698</p>  <p>D. 50 mm int</p>	<p>Ref. 2005 FERRARI - 308 gtbi/gtsi 4v - 328gtb/gts - Mondial 4v/T - 348 - 355 - F40 - F50 interc. with o.e.118338-154984</p>  <p>D. Int. 54 mm</p>	<p>Ref. 2006 FERRARI - 208 turbo - 512bb - Testarossa interc. with o.e.110313-146696</p>  <p>Int. 50 mm</p>
<p>Ref. 2009 FERRARI - 250 gt interc. with o.e. 147829</p> 	<p>Ref. 2010 FERRARI - 275 gtb/4 interc. with o.e. 20341</p> 	<p>Ref. 2012 FERRARI - 456 - 512tr - 550 - 575 - 612 - Testarossa Cat interc. with o.e.125917-154981</p>  <p>D. Int. 50 mm</p>
<p>Ref. 2013 FERRARI - 308 4v Usa - 328 cat - 430 - 512tr - Mondial 3.2 -Testarossa interc. with o.e.121426-154985</p>  <p>D. Int. 70 mm</p>	<p>Ref. 2014 MASERATI 6 CYL - 3500 gt - Mistral - Sebring interc. with o.e.5822/44756</p> 	

ACCESSORI: supporti scarico - exhaust system supportings

<p>Ref. 4001 FERRARI - DINO 206 - 246 - 365 gtb/4 interc. with o.e. 20410-102007-102947</p> 	<p>Ref. 4002 FERRARI - 208 gt4 - 365gtc4-gt/4 - 400-400i-412 interc. with o.e. 20457-20458-101999</p> 	<p>Ref. 4003 FERRARI - 208 gtb - gts - Turbo - 365 gtb/4 - gtc interc. with o.e. 115351-118223-20456</p> 
<p>Ref. 4004 FERRARI - 308 gt/4-gtbi 4v-gtb/gtsi 2v USA - 328 / Mondial 4v / 3.2 - Testarossa cat - 512 interc. with o.e. 106052</p> 	<p>Ref. 4007 FERRARI - 308 gtb-gts - 365 gt4 BB - BB 512 / 512i - Testarossa No Cat. interc. with o.e.101495-109453-116351</p> 	<p>Ref. 4008 FERRARI - 365 gt/4 2+2 - 400-400i-412 - Testarossa interc. with o.e. 103631</p> 
<p>Ref. 4012 FERRARI - 250 - 275 - 330 - 365 gtb4 interc. with o.e. 101497</p> 	<p>MASERATI interasse fori mm. 60 (40-65) interc. with o.e.55570/57351 interasse fori mm. 78 (70-78) interc. with o.e.54855 interasse fori mm. 90 interc. with o.e.54085</p> 	<p>Ref. 4031 Ref. 4032 Ref. 4033</p>



NOTE

A series of horizontal dashed lines providing space for a note.

MISSION

....THE SOUND OF POWER



Dal 1961 il nostro impegno è stato quello di sviluppare e proporre impianti di scarico ad alte prestazioni per le vetture italiane più prestigiose.

Siamo orgogliosi di aver collaborato con i tecnici più preparati ed appassionati.

Oggi vogliamo continuare in questo impegno affinché queste vetture rimangano tali, con il loro inconfondibile suono ed il loro personale design.

Il nostro primo obiettivo è quindi quello di salvare l'originalità delle vetture che hanno scritto una pagina importante nella storia dell'auto.

Abbiamo raccolto in questo documento i prodotti che nel corso degli anni si sono dimostrati i più importanti, ma non esitate a richiederci anche particolari non elencati e sarà un piacere potere aiutarvi.

Since 1961 our company mission has been to develop and offer high-performance exhaust systems for the most prestigious Italian cars.

We are proud to work with more highest quality technicians in the auto industry.

Today we are steadfast in our commitment to continue offering our customers the unique sound and personal design that has made our company so successful throughout the years.

Our first and foremost priority is to maintain the integrity of our original product and brand.

We have listed some of our signature product inside.

Please don't hesitate to contact us for any and all your parts and service needs.

Terra di motori



Classiche s.r.l.

Via F.lli Bonacatti, 40/A - 41034 Finale Emilia
(Modena) Italy

+39 347 75 44 935 (Alessandro)

+ 39 340 23 39 959 (Antonio)

+ 39 340 21 50 911 (Giuseppe)

classiche09@libero.it

www.classiche09.com

Made in Italy